

ROTANODE

E7239X

E7239FX

E7239GX



Rotating Anode X-Ray Tube Housing Assembly

- ◆ Rotating anode X-ray tube housing assembly for the purpose of general diagnostic X-ray procedures.
- ◆ Specially processed Rhenium-tungsten faced molybdenum target of 74 mm diameter.
- ◆ These tubes have foci 2.0 mm and 1.0 mm, and are available for a maximum tube voltage 125 kV with Single-phase or Three-phase generator.
- ◆ Accommodated with IEC 60526 type high-voltage cable receptacles.



General Data

IEC Classification **Class I**

Electrical:

Circuit (Center-grounded) Single-phase full-wave rectified
or Three-phase full-wave rectified

Operating Tube Voltage:

Radiographic 40 ~ 125 kV Max.

Fluoroscopic 40 ~ 125 kV Max.

Focal Spot:

Large Focus 2.0 mm

Small Focus 1.0 mm

Input Energy (at 0.1s):

	50 Hz	60 Hz
Large Focus	42.5 kW	47 kW
Small Focus	21 kW	22.5 kW

★The information contained herein is presented only as a guide for the applications of our products. No Responsibility is assumed by TOSHIBA ELECTRON TUBES & DEVICES CO.,LTD.(TETD) for any infringements of patents or other rights of the third parties which may result from its use. No license is granted by implication or otherwise under any patent or patent rights of TETD or others.

★The information contained herein may be changed without prior notice. It is therefore advisable to contact TETD before proceeding with the design of equipment incorporating this product.

Motor Ratings:

Duty		Starting		Running
Power source	(Hz)	50/60		50/60
Input power	(W)	1050	270	43
Voltage	(V)	200	100	40
Current	(A)	6.0	3.0	1.2
Min. Speed up	(s)	0.8	1.5	-
Capacitor	(μ F)	24	24	24

Anode Speed:

50 Hz 2700 min⁻¹ Min.
 60 Hz 3200 min⁻¹ Min.

Resistance between Housing and Low Voltage Terminals 2 M Ω Min.

Mechanical:

Dimensions: See dimensional outline

Overall Length 479 mm

Maximum Diameter 152.4 mm

Target::

Angle 16 degrees

Construction Rhenium-Tungsten-faced molybdenum

Permanent Filtration 0.9 mm Al / 75 kV IEC 60522/1999

Radiation Protection (To meet the requirements of IEC 60601-1-3):

Leakage Technique Factor 125 kV 4 mA

X-ray Coverage 354 × 354 mm at SID 750 mm

Weight (Approx.) 16 kg

High Tension Terminals To meet the requirements of IEC 60526

Cooling Method Natural or forced air

Tube Housing Model Number:

E7239X XH-121

E7239FX XH-126

E7239GX XH-150

Absolute Maximum and Minimum Ratings

(At any time, these values must not be exceeded.)

Maximum Tube Voltage:	
Radiographic	125 kV
Fluoroscopic	125 kV
Maximum Voltage to Ground	65 kV
Minimum Tube Voltage	40 kV
Maximum Tube Current:	
Large Focus	600 mA
Small Focus	350 mA
Maximum Filament Current:	
Large Focus	5.2 A
Small Focus	5.2 A
Filament Voltage:	
Large Focus (At max. filament current 5.2 A)	7.8 ~ 10.6 V
Small Focus (At max. filament current 5.2 A)	5.9 ~ 8.1 V
Filament Frequency Limits	0 ~ 25 kHz
Average Input Power	142 W (200 HU/s)
(Fluoroscopic, repeated radiographic or mixed exposure)	
Thermal Characteristics:	
Anode Heat Storage Capacity	100 kJ (140 kHU)
Maximum Anode Heat Dissipation Rate	475 W (667 HU/s)
Housing Heat Storage Capacity	900 kJ (1250 kHU)
Maximum Housing Heat Dissipation Rate:	
Without Air-circulator	180 W (15 kHU/min)

Environmental Limits

Operating Limits:	
Temperature	10 ~ 40 °C
Humidity	30 ~ 85 %
(No condensation)	
Atmospheric Pressure	70 ~ 106 kPa
Shipping and Storage Limits:	
Temperature	-20 ~ 70 °C
Humidity	20 ~ 90 %
(No condensation)	
Atmospheric Pressure	50 ~ 106 kPa

Warning

Warning to Interface with X-ray Generator

1. Housing Rupture

Never input over-rated power to x-ray tube assembly.

If the input power is extremely higher than specification, it may cause the over temperature of anode, insert tube glass shatter and ultimately the following serious problems due to generating over-pressure by oil vaporization inside housing assembly.

In such a critical condition, the safety thermal switch can not protect x-ray tube even if it works.

- * Housing sealing parts (cathode side) rupture
- * Human injury including burns due to hot oil escape
- * Fire accident due to flaming anode target

We strongly request that the x-ray generator should have a protective function which manages input power to x-ray tube assembly.

Cautions

Caution to Interface with X-ray Generator

1. Over Rating

X-ray tube assembly can be broken with applying just one over rated shot.
Please read the technical data sheets carefully and follow the instructions.

2. Inherent Filtration

The total filtration and the distance between x-ray focal spot and human body are regulated legally.
They should be complied with the regulation.

3. Safety Thermal Switch

X-ray tube assembly has safety thermal switch to prohibit further input power when the tube housing reaches to the specified temperature.

The switch should be hooked up with the x-ray generator which control output power to x-ray tube assembly.

Even if the switch works, never turn the system power off and the cooling unit should be activated.

4. Unexpected Malfunction

X-ray tube assembly may have the risk to be unexpectedly malfunctioning due to life termination or failure. If the serious problems caused by the above risk is expected, we recommend to have a contingency plan to avoid such a case.

5. New Application

If you use the product with new application not to be mentioned in this specification or with different type of x-ray generator, please contact to us for confirming its availability.

Caution for Installation, Adjustment and Maintenance

1. Qualified Persons

Only qualified persons who have technical training and professional knowledge can handle x-ray tube assembly.

2. Fragile Glass

X-ray tube is assembled with glass, therefore, it can be broken with the mechanical vibration or pulsed shock over 19.6m/s^2 (2G).

Careful handling is required to treat or transport.

3. Ground Terminal

X-ray tube assembly has ground terminal. Ground cable should be connected.

4. High Voltage

All x-ray tubes operate at voltages high enough to kill through electrical shock. Never touch the high voltage delivered plugs or terminals.

When direct access to such parts is required, the primary circuit should be disabled and high voltage capacitors/cables discharged.

5. High Voltage Plug

High voltage plug should be cleaned up and free from any physical damages. Silicon compound application is required for high voltage stability.

6. Operation Atmosphere

X-ray tube assembly is not allowed to use in the atmosphere of flammable or corrosive gas.

7. Protective Cover

X-ray tube assembly is not allowed to use without the protective cover attached.

8. Handling

Appropriate jig or tools are required for tube installation to avoid physical damages.

9. Returning Tube

X-ray tube assembly should be repackaged with the original material when it is returned back for quality examination in our factory.

Be careful to put the tube upside cathode. If the packaging is not proper, the tube may not be correctly examined.

Caution in Operation

1. X-Ray Radiation

X-ray tube assembly should have the beam limiting equipment mounted on the x-ray port to protect unnecessary radiation.

2. Dielectric Oil

X-ray tube assembly has dielectric oil contained for high voltage stability. As it is poisonous for human health, if it is exposed to the non-restricted area, it should be disposed as following to the local regulation.

3. Operation Atmosphere

X-ray tube assembly is not allowed to use in the atmosphere of flammable or corrosive gas.

4. Lead Disposition

X-ray tube housing is lined with lead to protect unnecessary radiation. As the lead powder or vapor is harmful for human health, it should be disposed as following to the local regulation or returned back to us with your cost of transportation. We dispose it in our facility with free of charge.

5. Safety Thermal Switch

X-ray tube has thermal switch to protect over heat on housing. As the housing temperature goes up to maximum 85°C, never touch on housing surface in operation.

6. Any Malfunction

Please contact to your system service person immediately, if any malfunction is noticed.

Caution Label

- (a) This label is a caution label to notify the user of the following point.
"Housing end cap is used to protect the electric shock and x-ray leakage."

Attachment position: X-ray tube assembly housing end cap



Maximum Rating Charts

(Absolute Maximum Rating Charts)

Conditions : Tube Voltage Three-Phase

Stator Power Frequency 60Hz

Focal Spot : 2.0 mm

Focal Spot : 1.0 mm

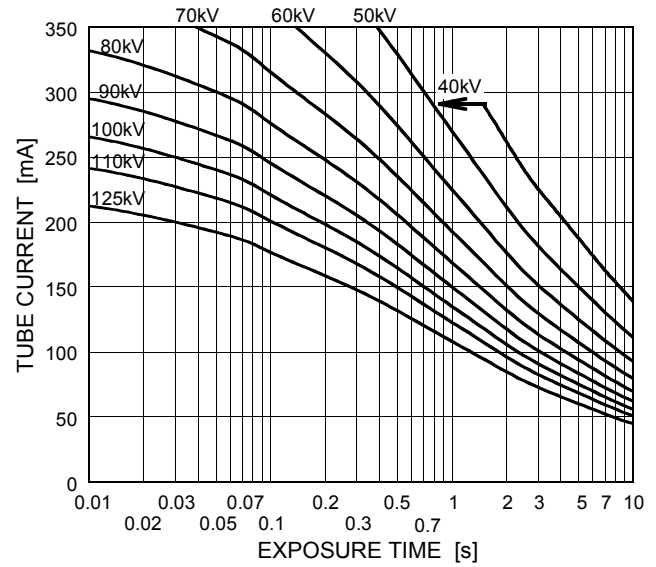
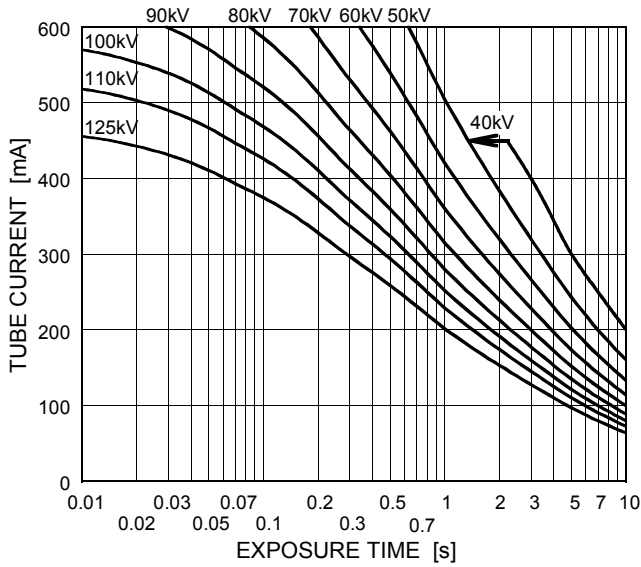

Conditions : Tube Voltage Single-Phase

Stator Power Frequency 60Hz

Focal Spot : 2.0 mm

Focal Spot : 1.0 mm

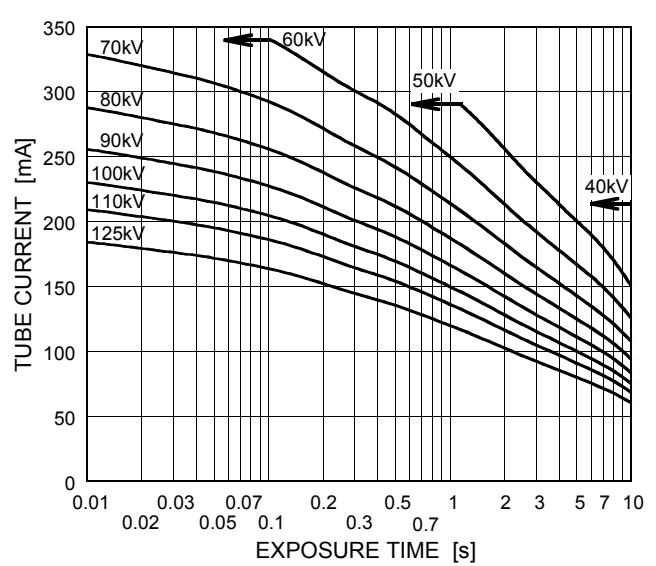
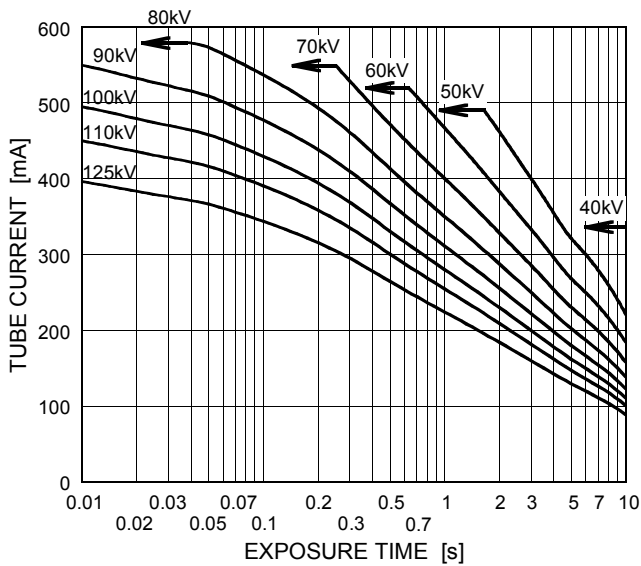

Maximum Rating Charts

(Absolute Maximum Rating Charts)

Conditions : Tube Voltage Three-Phase

Stator Power Frequency 50Hz

Focal Spot : 2.0 mm

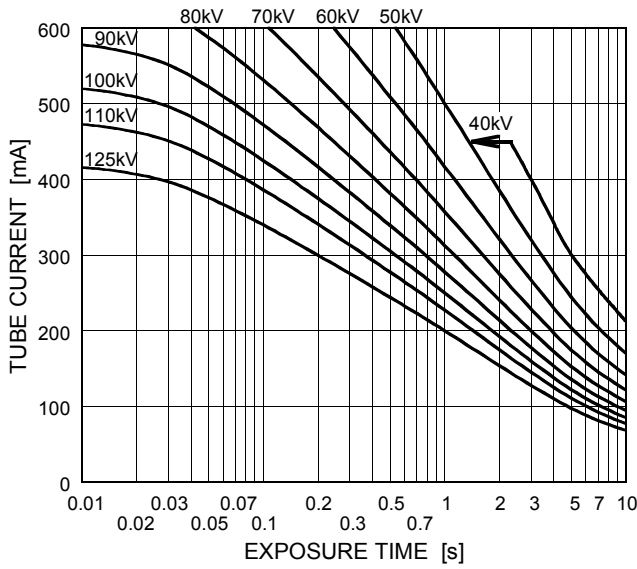

Focal Spot : 1.0 mm

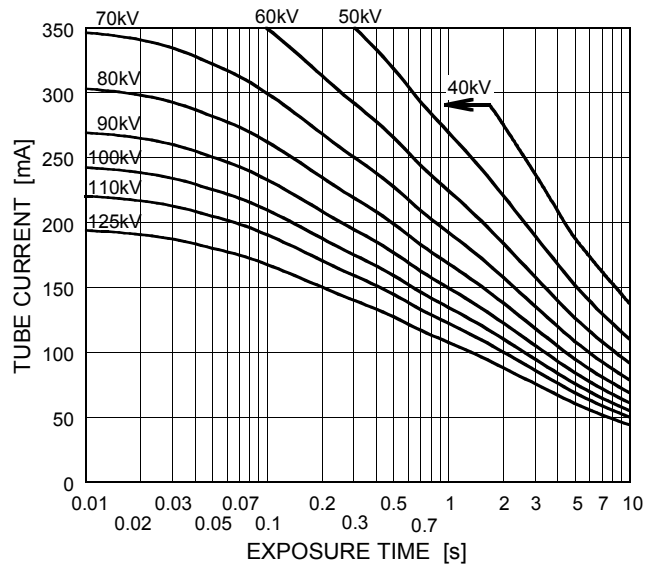

Conditions : Tube Voltage Single-Phase

Stator Power Frequency 50Hz

Focal Spot : 2.0 mm

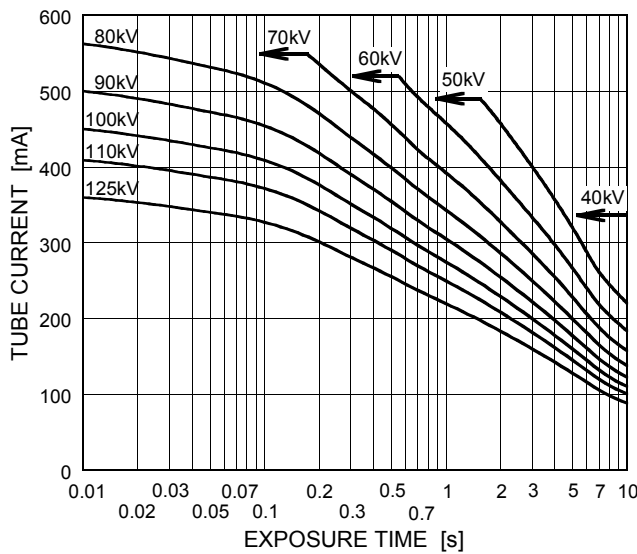

Focal Spot : 1.0 mm

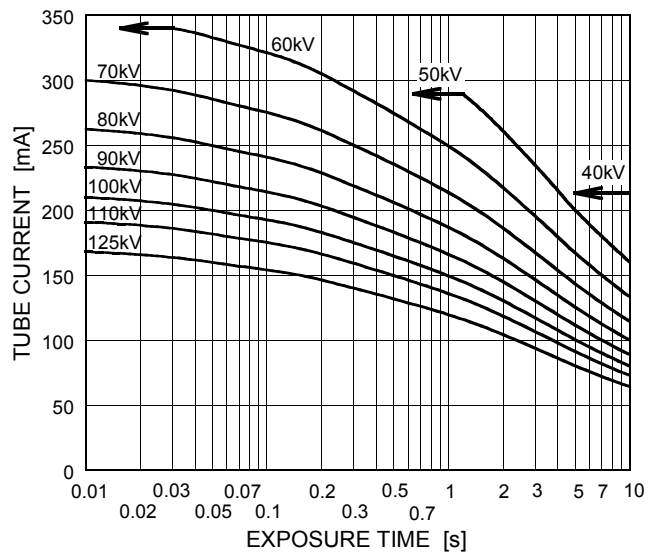

Emission & Filament Characteristics

Three-Phase

Focal Spot : 2.0 mm

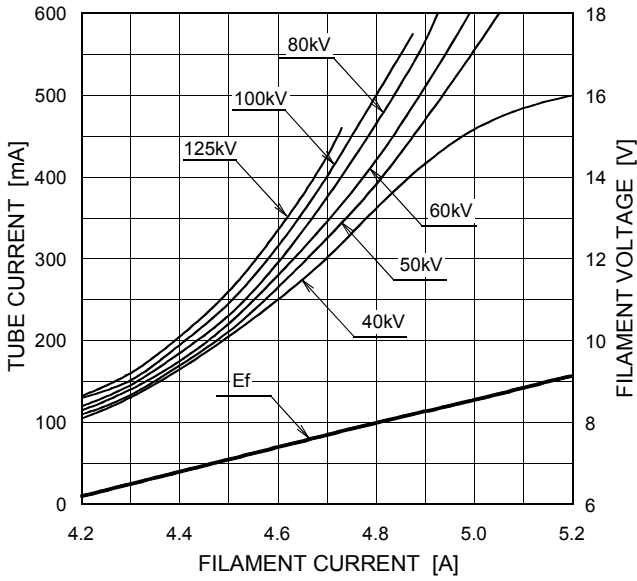

Focal Spot : 1.0 mm

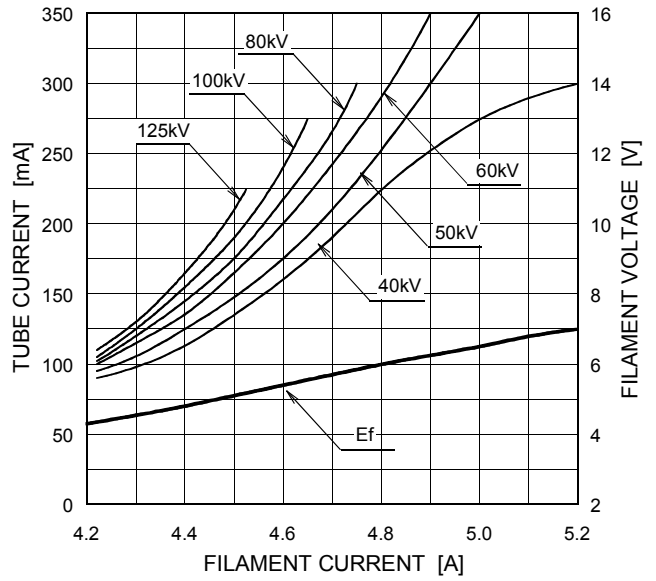

Single-Phase

Focal Spot : 2.0 mm

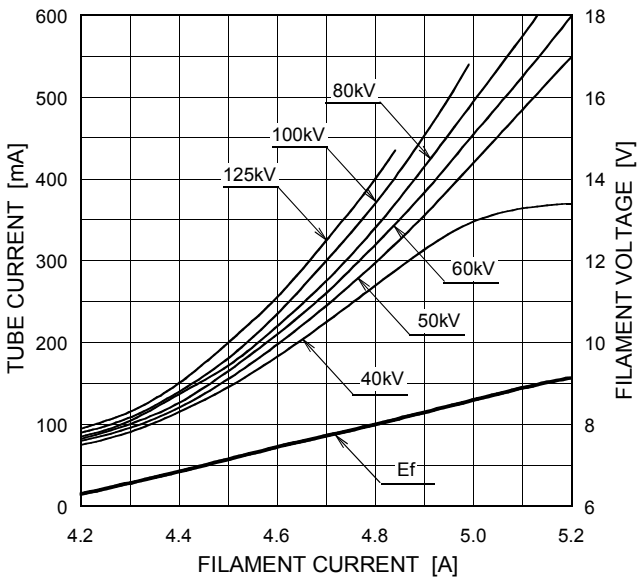

Focal Spot : 1.0 mm

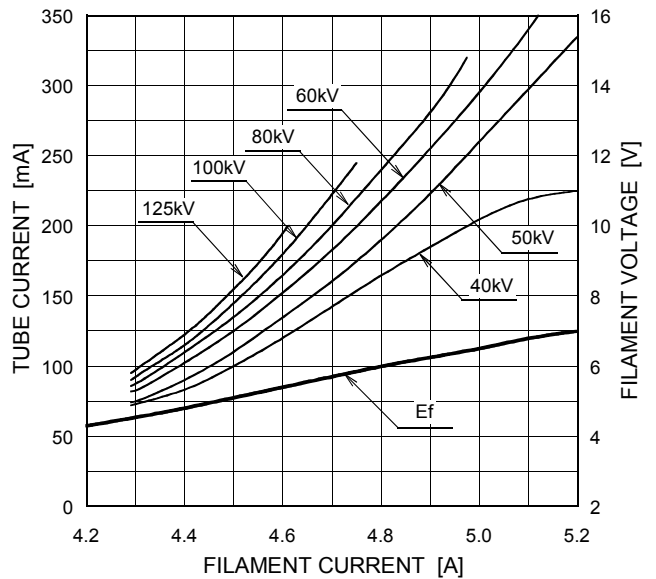

Thermal Characteristics

Housing Thermal Characteristics

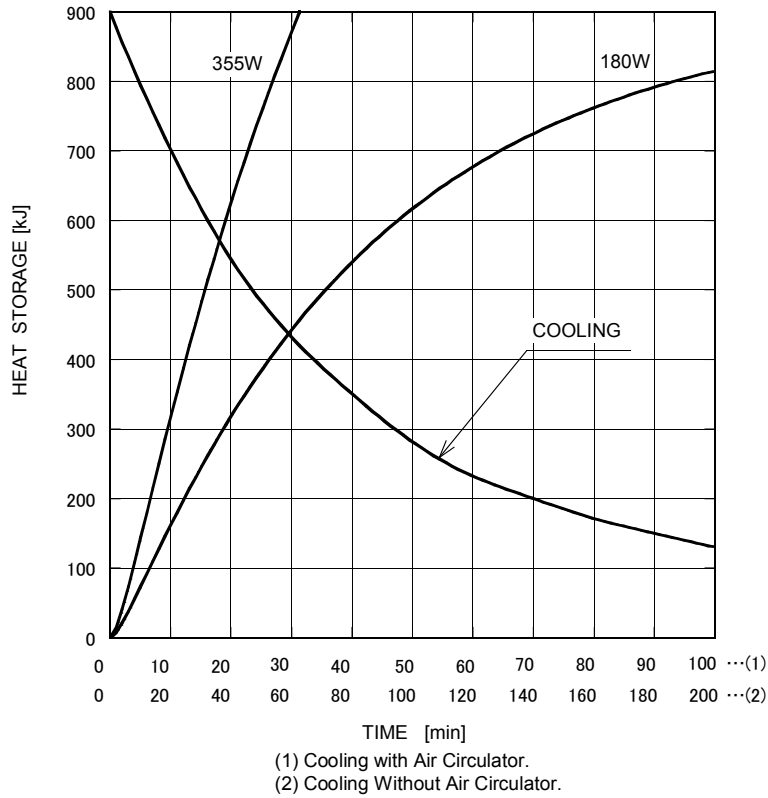

Anode Thermal Characteristics

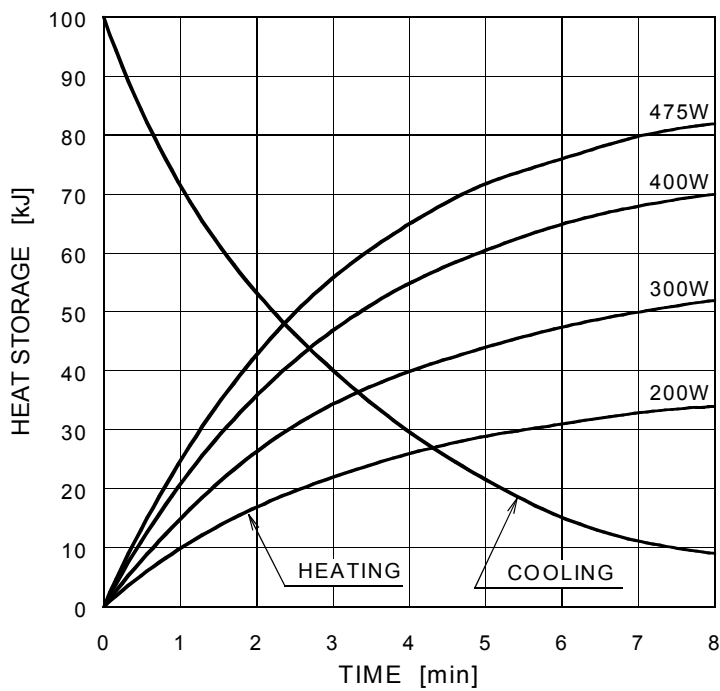

The heating curves are showing examples of average input power to the anode in operation.

Dimensional Outline of E7239X

Unit mm

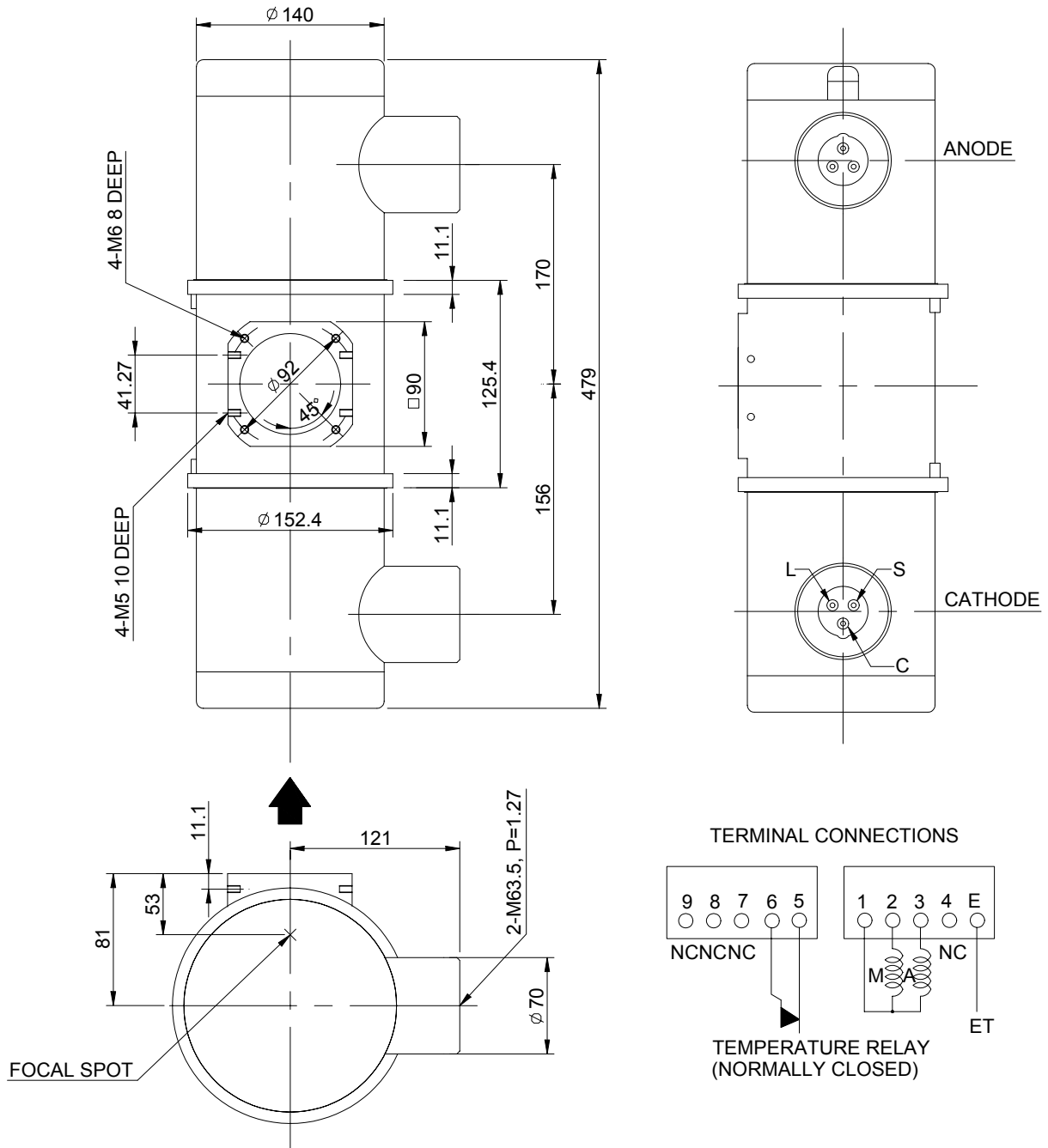

C : COMMON
 L : LARGE FOCUS
 S : SMALL FOCUS
 M : MAIN WINDING OF THE STATOR
 A : AUX. WINDING OF THE STATOR

NC: NON-CONNECTION
 ET: EARTH TERMINAL
 ▲ : CENTRAL X-RAY
 ANODE & CATHODE TERMINAL
 : IEC 60526 TYPE

Dimensional Outline of E7239FX

Unit mm

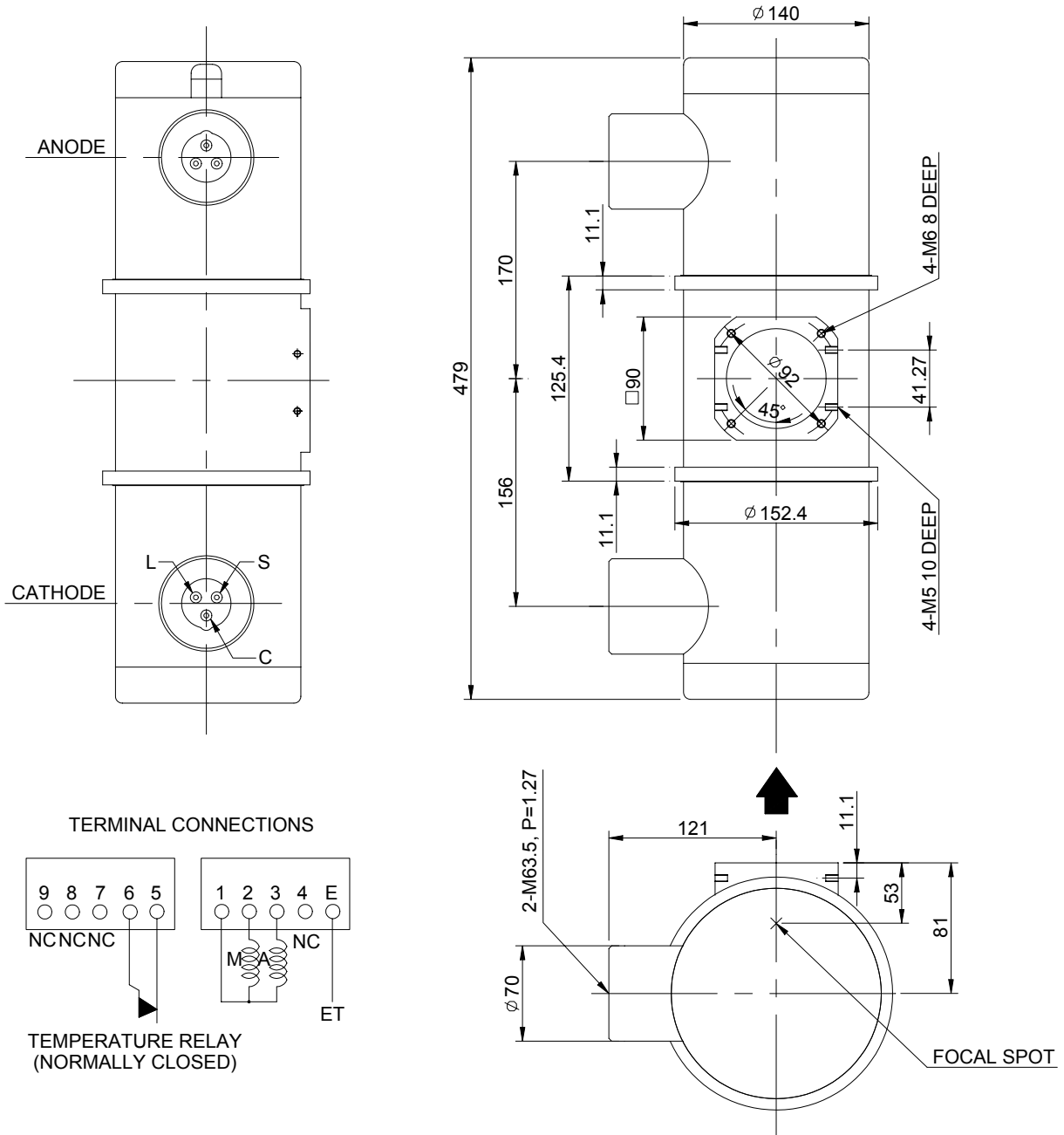

C : COMMON
 L : LARGE FOCUS
 S : SMALL FOCUS
 M : MAIN WINDING OF THE STATOR
 A : AUX. WINDING OF THE STATOR

NC: NON-CONNECTION
 ET: EARTH TERMINAL
 ▲ : CENTRAL X-RAY ANODE & CATHODE TERMINAL : IEC 60526 TYPE

Dimensional Outline of E7239GX

Unit mm

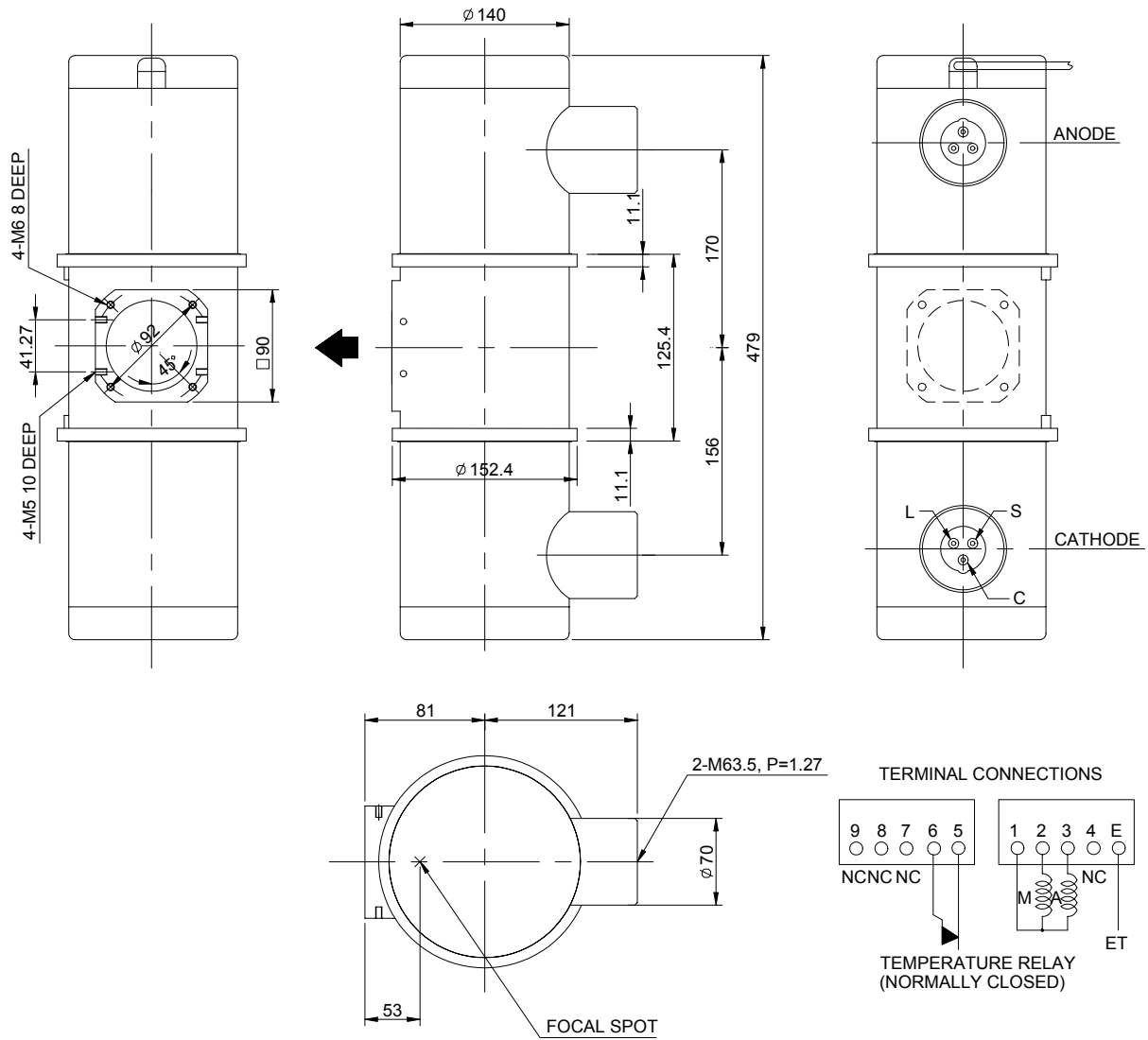

C : COMMON
 L : LARGE FOCUS
 S : SMALL FOCUS
 M : MAIN WINDING OF THE STATOR
 A : AUX. WINDING OF THE STATOR

NC: NON-CONNECTION
 ET: EARTH TERMINAL
 ◆ : CENTRAL X-RAY ANODE & CATHODE TERMINAL
 : IEC 60526 TYPE

Overseas Subsidiaries and Affiliates

- **Toshiba America Electronic Components, Inc.**
One Parkway North, Suite 500, Deerfield, IL 60015-2547, USA
Phone +1-847- 945-1500 Fax +1-847- 945-1044

- **Toshiba Electronics Europe**
Riverside Way, Camberley, Surrey. GU15 3YA U.K.
Phone +44 (0) 1276 694600 Fax +44 (0) 1276 694800

TOSHIBA ELECTRON TUBES & DEVICES CO., LTD.

Sales & Marketing Department

1385 SHIMOISHIGAMI, OTAWARA-SHI, TOCHIGI-KEN, 324-8550, JAPAN

PHONE : +81-287-26-6668 FAX : +81-287-26-6061

<http://www.toshiba-tetd.co.jp/>

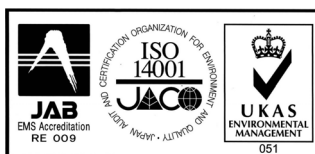

Toshiba Electron Tubes & Devices Co., Ltd. meets the Environmental Management System Standard , ISO 14001



Toshiba Electron Tubes & Devices Co., Ltd . meets internationally recognized Standards for Quality Management System ISO 9001, ISO 13485