

S E R I E S

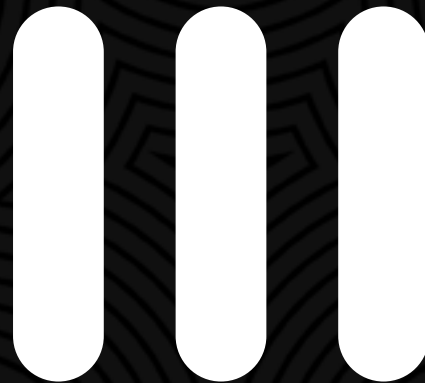

# OUR GLOBAL PRESENCE



NIBAV STANDS TALL WITH 1600 EMPLOYEES IN  
OVER 31 EXPERIENCE CENTRES, SPREAD ACROSS THE GLOBE



BRINGING THE BEST OF INDIA TO YOU



nibav®  
HOME LIFTS



## nibav Lifts

Introduced to the industry in 2002, NIBAV is a pioneer in manufacturing patented pneumatic-driven lifts by incorporating unparalleled engineering excellence and state of the art pneumatic elevation systems.

## Our Commitment

Engineered to use AIR, these elevators are easy to install and have a panoramic design, perfect for both retrofit and new construction projects. Manufactured in accordance with European Standards, we at NIBAV are committed to delivering par excellence as we are the only TÜV SÜD certified Indian manufacturer.



## Our Promise

Safety is extremely important at home because it is the place where we spend most of our time and where we should feel the most secure. Our commitment and promise is to make your house a safe and comfortable home.

# Enlivening Spaces

## SERIES

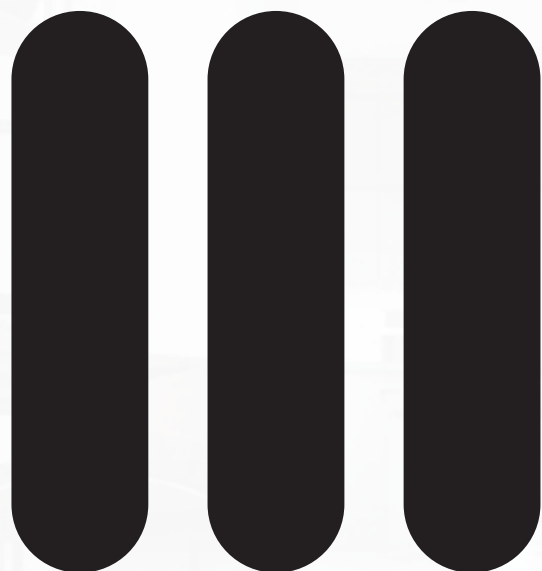

Maximum Stops : 4 Stops (G+3)

Max Travel Height : 13500mm / 531in

Capacity : 210kg / 462lbs

Clear Space Required : 1010mm / 40in

Internal Cabin Diameter : 749mm / 29in

External Cylinder Diameter : 935mm / 37in



nibav  
— HOME LIFTS —

Reimagining

Accessibility



SERIES III

**MAX**

Maximum Stops	: 4 Stops (G+3)
Max Travel Height	: 13500mm / 531in
Capacity	: 240kg / 529lbs
Clear Space Required	: 1430mm / 56in
Internal Cabin Diameter	: 1160mm / 46in
External Cylinder Diameter	: 1343mm / 53in



Wheelchair Compatible



# Advanced Suspension System

Designed with a unique suspension, NIBAV's Series III guarantees an exceptionally seamless landing at every floor stop. Such a suspension mechanism expertly regulates the elevator's descent to align with the stopping level, delivering an unrivaled, razor-smooth landing experience. This revolutionary characteristic not only elevates the overall ride quality for passengers but also diminishes the strain exerted on the elevator's components, thus potentially enhancing their longevity. Incorporating this advanced technology into elevators is a remarkable step towards enabling vertical transportation that is both more efficient as well as luxurious.

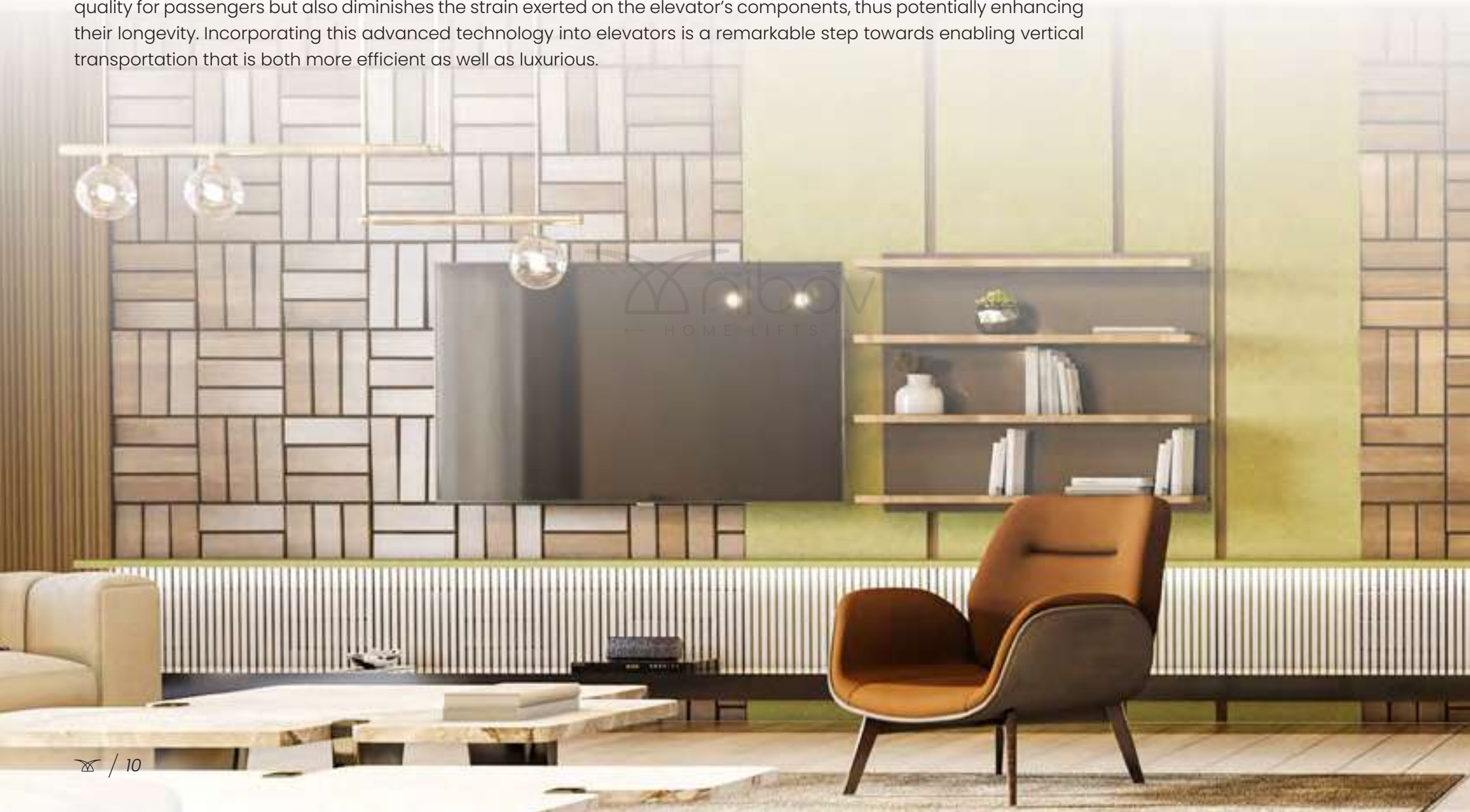



MIBOV

MIBOV  
— HOME —



## Futuristic Engineering

Employing state-of-the-art manufacturing techniques and revolutionary materials, the elevators' design guarantees unparalleled sturdiness. In addition, the absence of visible screws, welds, and rivets not only imparts a refined appearance but also elevates the level of safety. Our masterpiece sets a new standard in elevator design, leaving all others in its wake.

**NIBAV**  
HOME LIFTS



nibav  
— HOME LIFTS —

## Modular Enhancements

NIBAV lifts come in a completely knocked down manner directly from the manufacturing unit. This enables the lifts to be installed in under 24 hours. Also, these lifts are compatible with all other modifications that may be needed in the course of its lifetime. You can add or remove additional stops and also make customized improvements for the interiors.



## Self Supported Structure

NIBAV Lifts are stand alone installations that do not require any supporting beam, column or wall. The external shaft is made of polycarbonate glass that is 250 times stronger than normal glass.

## 360° Panoramic View

Our elevators are designed with utmost consideration for comfort and safety. Featuring panoramic views, these elevators aim to alleviate claustrophobic feelings by offering expansive vistas.

The transparency of the elevators allows for a clear view of one's home, providing a sense of security and connectivity to those within the dwelling. Furthermore, this element imbues the elevators with a visual appeal, ensuring a truly exceptional experience.

nibav®  
HOME LIFTS

# Personalized Aesthetics

Owning a custom elevator goes beyond transportation - it is a statement of esteem. The unique design and custom engraving within the cabin reinforces this connection, conveying that the elevator is truly one-of-a-kind and built specifically for the homeowner.





nibav  
— HOME LIFTS —

# Pioneering Safety Mechanisms

NIBAV has developed an elevator specifically designed for private residences, taking into consideration the safety of children and elders who may use it. With safety as our paramount concern, we have implemented four layers of safety measures that exceed standard requirements. Our aim is to provide our customers with an elevator that is absolutely safe in all aspects, giving them peace of mind and ensuring the safety of their loved ones. With our commitment to safety, you can trust that our elevator is the right choice for your home.

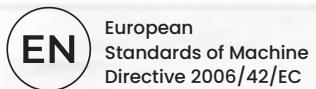

European Standards of Machine Directive 2006/42/EC



Certified



TÜV SÜD Certified  
ISO 9001:2015

# 4 LAYERS OF SAFETY

## DID YOU KNOW THAT OUR ELEVATOR'S TECHNOLOGY IS THE SAFEST ON THE PLANET?

1. In case of a power outage during the operation of the elevator, the elevator's car automatically descends to the ground floor. The passenger can open the door manually and step out without any technical assistance.
2. In any unfortunate event of the elevator getting stuck between two floors, the 'Emergency Landing Button' placed inside & outside the elevator's cabin enables the user to land the elevator on the ground floor.
3. In case of Pneumatic pressure failure or if the lift travels beyond the designated speed, the 'Sure Stop' safety feature locks the elevator's car within 2 inches.
4. The Conventional Lock on the door can be used to manually unlock the elevator, in case of an emergency.



3 layers of door  
lock safety

**55dB\***

Soundproof 2.0



Power back-up

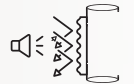

Noise  
insulated cabin

\*The decibels were recorded at a controlled environment using precision mechanisms

alexa integration





 nibav®  
— HOME LIFTS —



## Adaptability

Our elevators require 3.3 feet of diametrical space, out of which, the cabin occupies 3 feet of diametrical space. The sleek, compact design and technological simplicity ensures that our elevator makes maximum utilization of your home space. The elevator can be installed without any requirement for pit/headroom installation, flooring reinforcements / structural changes.



## Easy and Mobile

With its unique ability to be 'Completely knocked down' and moved from one location to another, NIBAV lifts are perfect for you to plan a change of home layouts, locations or even add additional stops to your existing lifts. Our lifts are designed to grow with you and your family and are easy to install, operate, and maintain, making it a convenient and hassle-free addition to your home.



## Return to Home

Our lift is equipped with a unique feature that allows it to descend to a specific floor when not in use, rather than remaining stationary on a random floor. This means that you can program the lift to wait for you on the ground floor when you enter your home.



## Flexibility

With our patented technology, a G+1 elevator can be converted into a G+2 or a G+3 at any given point in time. The elevator can also be completely dismantled and reinstalled in case of relocation.





Hidden  
Adjustable Fan



Zero Visible  
Screws



Curved Designer  
Profile



Ambient  
Glow Light



Largest Panoramic  
Cabin



Custom Built  
Engraving Inside  
Cabin

nibav®  
— HOME LIFTS —

## WHAT'S NEW IN SERIES III

- AESTHETICS
- SAFETY
- PERFORMANCE

# AESTHETICS

We believe a cohesive aesthetic can create a sense of harmony and balance throughout the house, while unique and eye-catching elements can add interest and spark joy. Ultimately, aesthetics are a reflection of one's personal style and taste, and when thoughtfully curated, can transform a house into a warm and welcoming home.



Series II  
**STANDARD  
SHAPED PILLAR**



Series III  
**CURVED  
DESIGNER PROFILE**



Series II  
**STEEL DOOR  
WITH FRAMES**



Series III  
**ALUMINIUM DOOR WITH  
FRAMELESS DESIGN**



Series II  
**SIMPLE DOOR  
HANDLES**

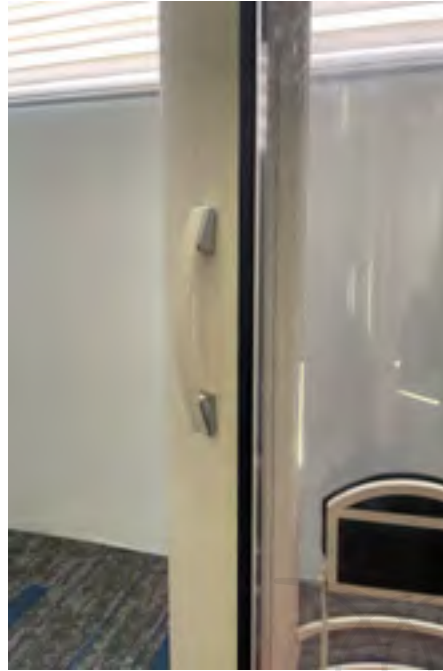

Series III  
**DOOR HANDLES PAINTED TO  
MATCH SHAFT COLOUR**



Series II  
**CONNECTOR HOLES SEEN  
ON ALL PILLARS**



Series III  
**NO CONNECTOR  
HOLES**





Series II  
**EXPOSED  
DOOR HINGES**



Series III  
**CONCEALED HINGES FOR  
SEAMLESS FINISH**



Series II  
**MDF  
CEILING**



Series III  
**PAINTED METAL CEILING  
WITH NO FIXING SCREWS**





Series II  
**VISIBLE SENSORS  
ON EVERY STOP**



Series III  
**CONCEALED  
SENSORS**



Series II  
**GROOVED  
CYLINDER RINGS**



Series III  
**SMOOTH AND  
FLUSHED FINISH**

# SAFETY



Safety has always been a top priority at NIBAV which goes to talk about our sophisticated designs of four levels of safety features such as emergency button, automatic descent, alarms, etc. Manufactured in accordance with European Standards, our elevators are CE certified and have a ISO 9001:2015 certification from TÜV SÜD, that ensures that a product, service, or process has passed all safety testing and meets relevant compliance requirements.

# SAFETY FEATURES

Series II

Standard Profile

Cabin Phone - Optional

Standard Landline Connection

Electric Door Lock

ASME Compliant

Series III

Curved Edges

Cabin Phone - Standard

Stationary GSM Module **NEW**

Electric and Electronic Door Lock **NEW**

European Standards - CE Certified

ISO 9001:2015 Certification by TÜV SÜD

Aux Battery for Light / Fan / Alarm & Phone **NEW**



# PERFORMANCE



Our state-of-the-art elevators stand at the pinnacle of innovation, style and elegance, setting a new standard for home elevators in the industry. The Series III is a true work of engineering and design, crafted to perfection with a focus on functionality, safety, and aesthetics. This work of art will elevate your home to new heights, both in terms of style as well as convenience.

# PERFORMANCE FEATURES

Series II

150kg / 330lbs

Standard Main Board

Standard Built in Unit / Split

Electrical Power Board

Series III

210kg / 463lbs

Upgradable Main Board

(Optional) Sound Proof Built in Unit / Split

Electronic Power Board - Noise Free

Patented - Fused Locking Technology **NEW**

Trip Counter with Usage History **NEW**

Auto Return to Any Desired Floor **NEW**

Seamless Joints **NEW**

Lifetime Warranty on Seal and Motors **NEW**





nibav Series  
**SPECIFICATIONS**

nibav®  
— HOME LIFTS —

	Series II	Series III	Series III Max
<b>SPECIFICATIONS</b>			
Zero Pit	Yes	Yes	Yes
Unbreakable Glass Made of Polycarbonate	Yes	Yes	Yes
Self-Supported Lightweight Hybrid Shaft	Yes	Yes	Yes
Single Phase Power Consumption	Yes	Yes	Yes
Zero Power while descend	Yes	Yes	Yes
3 Axis Adjustable Door Hinges	Yes	Yes	Yes
GLE Technology (Grease less Elevator)	Yes	Yes	Yes
CKD Kit (Completely Knocked Down)	Yes	Yes	Yes
Lifetime Warranty on Seal & Motor	-	Yes	Yes
No. of Colours	2	14	14
Carpet Colours Available	Red	Beige / Red / Grey	Beige / Red / Grey
Standard Concealed Fan	Yes	-	-
Hidden Fan	-	Yes	Yes
Standard Single Spot Light	Yes	-	-
Ambient Glow light	-	Yes	Yes
Custom Built engraving inside cabin	-	Yes	Yes
<b>AESTHETICS</b>			
360° panoramic glass view	Yes	Yes	Yes
Curved designer profile	-	Yes	Yes
No connector holes on the shaft joints	-	Yes	Yes
Cylinder joint cover - matching designer profile	-	Yes	Yes
Concealed Hinges with No Projected Visible Metal Cover	-	Yes	Yes
Invisible Sensors on the Shaft	-	Yes	Yes
Cabin Colour Matching to Lift Colour	Yes	Yes	Yes

	Series II	Series III	Series III Max
Panoramic Frameless Aluminium Door	-	Yes	Yes
Door Handles Painted to Match Lift Colour	-	Yes	Yes
Cabin Base Cover Plates	-	Yes	Yes
MDF Ceiling	Yes	-	-
Zero Visible Screws on Shaft / Cabin & Doors	-	Yes	Yes
No Visible Springs on Cabin Base	-	Yes	Yes
Largest Panoramic Cabin	-	Yes	Yes
<b>SAFETY</b>			
DC Powered Cabin	Yes	Yes	Yes
Dual HCC Brakes (Hardened Cross Compound)	Yes	Yes	Yes
Zero Sharp Edges Improving Safety of the Family Members	Yes	Yes	Yes
AUX Battery to Power Light, Fan, Alarm and Phone	Yes	Yes	Yes
Electric Door Lock for Safety Triangle	Yes	Yes	Yes
Emergency Alarm	Yes	Yes	Yes
Cabin Phone with GSM	Yes	Yes	Yes
EEM (Electric, Electronic & Mechanical) Landing Door	Yes	Yes	Yes
Child Safety Switch	Yes	Yes	Yes
<b>PERFORMANCE</b>			
Patented Fused Locking Technology - FLT	Yes	Yes	Yes
PLL (Precision Landing Levers)	Yes	Yes	Yes
Silent Main Board with Software Updates	-	Yes	Yes
Track Errors Logs with Usage History	-	Yes	Yes
Self-Supported Hybrid Structure	Yes	Yes	Yes
Capacity	150kg / 330lbs	210kg / 463lbs	240kg / 529lbs

	Series II	Series III	Series III Max
No. of People	2	2	4
Single Phase Power Consumption	Yes	Yes	Yes
Zero Power While Descend	Yes	Yes	Yes
Auto Return When Unused	-	Yes	Yes
High Performance Seal – Carbon Edition	-	Yes	Yes
Wheelchair Compatibility	-	-	Yes
Sound Proof Model*	-	Yes (62dB)	Yes (62dB)
Split Model*	Yes (64dB)	Yes (55dB)	Yes (55dB)
<b>DIMENSIONS</b>			
External Shaft Diameter	935mm / 36.8in	935mm / 36.8in	1343mm / 52.8in
Internal Cabin Diameter	749mm / 29.4in	749mm / 29.4in	1160mm / 45.6in
Cabin Height	1935mm / 76.1in	1950mm / 76.7in	1950mm / 76.7in
Clear Door Opening	508mm / 20in	508mm / 20in	805mm / 31.6in
Minimum Headroom	2436-2800mm / 95.9-110.2in	2436-2800mm / 95.9-110.2in	2436-2800mm / 95.9-110.2in
<b>OPTIONS</b>			
Cabin chair with handrail	-	O	O
Handrail only	-	O	O
Earthquake Brackets	O	O	O
Floor cover plates	O	O	O
Ceiling cover plates	O	O	O

\*The decibels were recorded at a controlled environment using precision mechanisms

(Yes) Available / (-) N/A / (O) Optional

# COLOUR OPTIONS

NIBAV's wide range of colour options make sure the elevator will blend with any interior decor.

## STANDARD



Pure White



Cream White

## PREMIUM



Midnight Black



Ashen Grey



Viridian Green



Sienna Brown



Scarlet Red



Cobalt Blue

## METALLIC



Gold



Silver

## LIMITED EDITION



Mahogany Brown  
( Matt / Glossy )



Russet Brown  
( Matt / Glossy )



Umber Brown  
( Matt / Glossy )



Carbonic Fiber  
( Matt / Glossy )

## CARPET



Taupe Beige



Scarlet Red



Ashen Grey

# HEAD TYPES

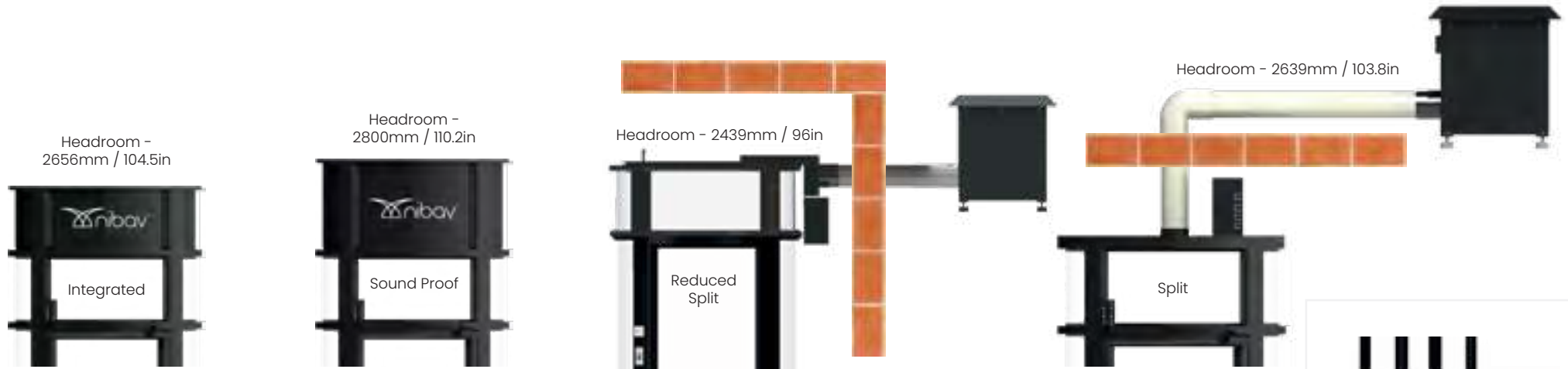

## ACCESSORIES



FOLDABLE CHAIR



## MULTIPLE DOOR ACCESS

The door access can be customized to be on different sides of the elevator for different floors. This flexibility of the elevator comes in very handy, especially for homes that have been planned and built without elevator space. This technology removes a lot of complications faced by every home elevator buyer.





nibav<sup>®</sup>  
HOME LIFTS

# HERE'S WHAT THEY HAVE TO SAY



FOR TESTIMONIALS



"As a chef, I was finding it hard to have regular access to my workspace at the basement, but the NIBAV elevator's compact design made it the perfect solution. It not only looks sleek and stylish, but it also provides convenient access to my kitchen on the lowest level of my house"

***Chef John Cristopher, Malaysia***



"I am so grateful for my NIBAV elevator. It allows me to maintain my independence and move around my home with ease. Thank you, NIBAV!"

***George Modest, Australia***



"Climbing stairs has always a great form of exercise but owing to my knee injuries, I wasn't able to take the stairs as often and also found it difficult to access my home gym. NIBAV lifts has eliminated the problem entirely as I don't add any additional stress to my knees"

***Rashid, UAE***



"NIBAV Lifts has been a big boon for me and my wife as we were finding it difficult to move around the house. It has been a huge relief to use an elevator that offers these many safety features as the NIBAV Lift"

***Frank, Australia***



"I always adhered to the principles of Vastu. I never thought I could have an elevator in my home without digging a pit, but NIBAV made it possible. They have installed it without any disruptions to my home's Vastu. Thank you, NIBAV"

***Manish Tiwari, India***



"As a parent, I am grateful to NIBAV Home Lifts for their commitment to safety, which is evident in the EN, CE, and TÜV SÜD certifications. Their dedication to safety gives me confidence in the products I purchase for my home"

***Deion Kentay, Nigeria***



A JEWEL TO YOUR HOME



+91 78248 12121



info@nibavlifts.com



www.NibavLifts.com



Nibav Towers, 1st street, Kazura Garden, Palavakkam, Chennai, Tamil Nadu - 600041

The product shown in the brochure may vary from the actual product. The Brochure is only for your reference. Please refer to the respective technical documents as items may change due to continuous improvement. Conditions apply.