

Manion's

MILLWORK

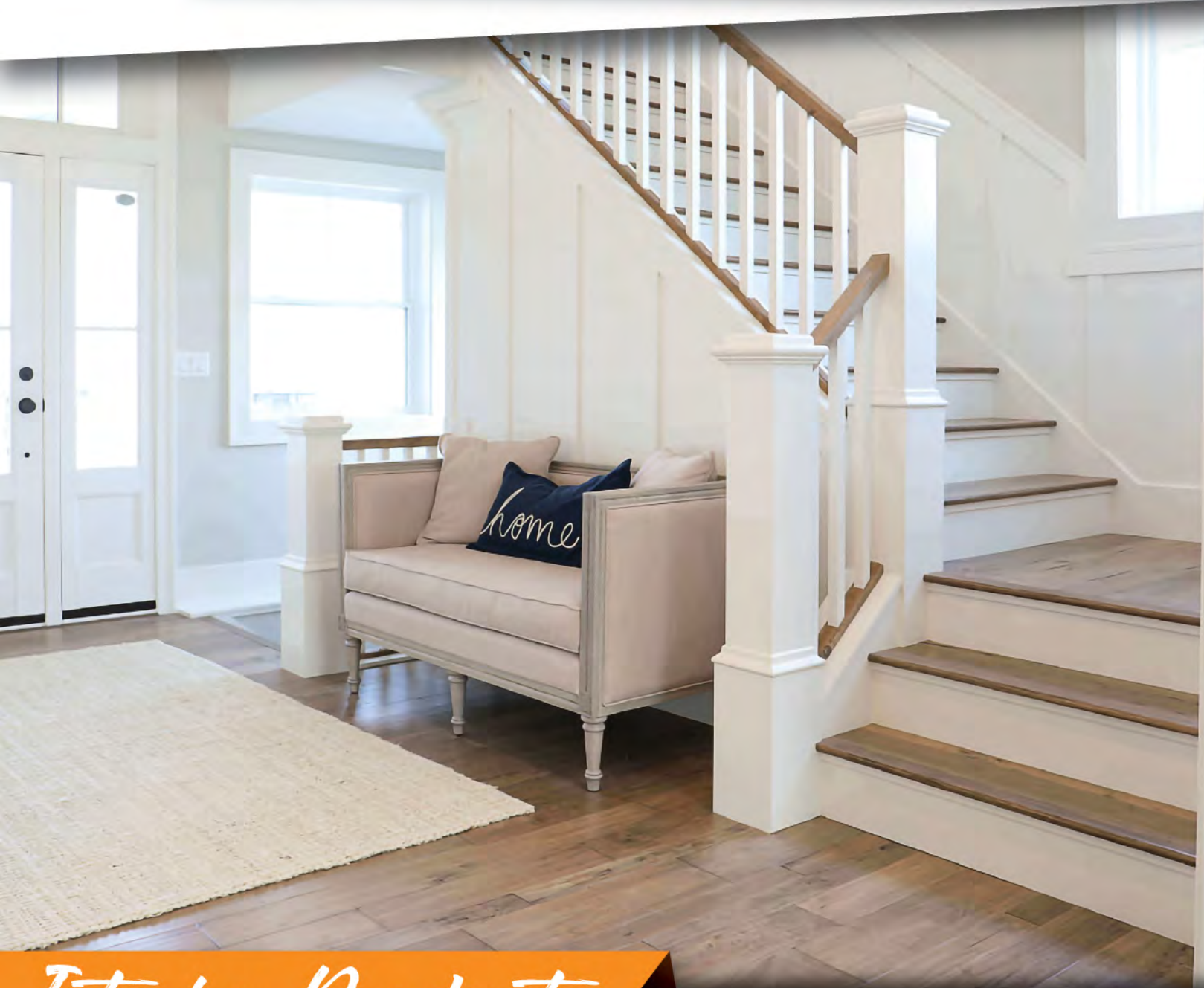

Interior Products

**WHOLESALE BUILDING SUPPLIES
MILLWORK DIVISION**

www.manionswholesale.com

Open your door to all the possibilities

Manion's Millwork

OUR MISSION

To provide great customer service in a timely manner, with dependable, reliable delivery.



**Superior
Wisconsin**



**Saint Cloud
Minnesota**

Table of Contents

Doors	1
Wood Species	2-3
Door Slab Profiles.....	4-5
French Doors & Sidelights	6
Rustic Series	7
Door Specifications	8
Door Toppers.....	9
Pocket Doors	10
Barn Doors.....	11
Hardwood Mouldings	12
Hardwood Casing.....	13-14
Hardwood Baseboards	15
Pine & Fir Mouldings.....	16
Primed Mouldings	17
Solid S4S Boards & Misc. Mouldings ..	18
Crowns & Cove	19
EZ Beam & Trim Kits.....	20
Stair Parts	21
Stair Systems.....	23
Newels.....	24
Balusters.....	25
Handrail Components	26
Treads & Risers.....	27
Accessories.....	28
Standard Pre-finished Colors.....	29

WITH MANION'S MILLWORK YOU'LL FIND EVERYTHING YOU WILL NEED TO ENHANCE YOUR HOME'S BEAUTY, APPEAL AND VALUE ALL FROM A SINGLE SOURCE.



Manion's 
Millwork
Doors

Open your door to all the possibilities.

Wood Species

Doors



KNOTTY ALDER
SL-20-A* O, POP, KA



POPLAR
SL-34* O, M, POP, KA



HICKORY
SL-60* O, M, POP



KNOTTY ALDER
SL-20-VA* KA



MAPLE
15-Lite*
O, M, POP, KA
1-Lite*
O, M, POP, KA



ALDER
SL-809-C



RED OAK
SL-10



CHERRY
SL-20



RED OAK
SL-33



*Stock items

The doors on this page are pre-finished. Go to page 29 for pre-finishing options.

Quality Doors for Your Home

Doors



KNOTTY PINE
6-PNL* DH



KNOTTY PINE
3-PNL*



VG PINE
6-PNL* DH



BIRCH
SL-45



MDF
SL-30



KNOTTY ALDER
SL-20-BF-A* KA



KNOTTY PINE
SL-20-V



HICKORY
SL-50



MAHOGANY
SL-34



RUSTIC RED OAK
SL-20-RA-BM



MAPLE
SL-40-A



WALNUT
SL-60



RUSTIC OAK
SL-61

The doors on this page are pre-finished. Go to page 29 for pre-finishing options.



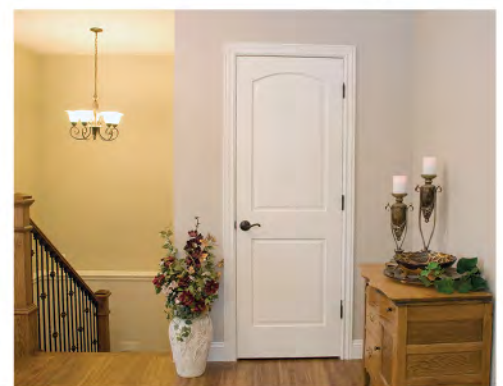
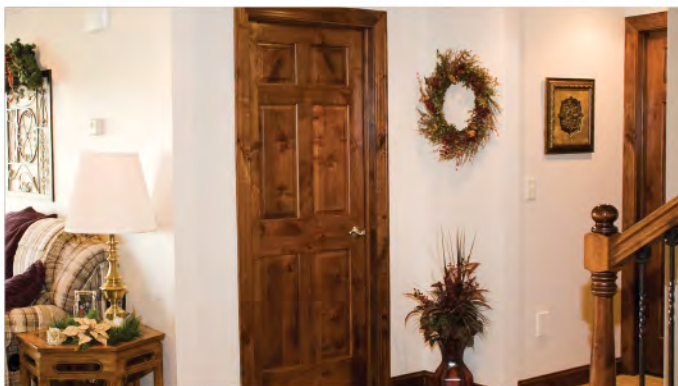









































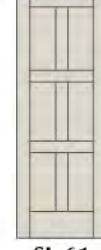

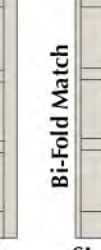











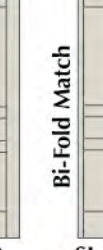

*Stock items



Door Slab Profiles

Doors

*Denotes standard stock profile
Panel and Sticking Profiles

				<i>Bi-Fold Match</i>								Profile 8315* 3/8" Veneered Flat Panel		Profile 5925 3/8" Veneered Flat Panel
						<i>Bi-Fold Match</i>						Profile 5426 3/8" Veneered Flat Panel		Profile 7797 3/8" Veneered Flat Panel
						<i>Bi-Fold Match</i>						Profile 6715 3/4" Veneered Raised Panel		Profile 5282* 3/4" Veneered Raised Panel
				<i>Bi-Fold Match</i>									<i>Bi-Fold Match</i>	
					<i>Bi-Fold Match</i>									
			<i>Bi-Fold Match</i>						<i>Bi-Fold Match</i>			SL-3403		

Door Slab Profiles

Doors



SL-10-A



SL-10-A



SL-22-A



Bi-Fold Match

SL-10-BF-A



SL-61-C



SL-30-BF-C



SL-21-A



SL-34-A



SL-46-A



Bi-Fold Match

SL-21-BF-A



SL-33-A



SL-42-A



SL-43-A



SL-62-A



Bi-Fold Match

SL-33-BF-A



SL-10-C



SL-22-C



Bi-Fold Match

SL-10-BF-C

All door profiles are available with raised or flat panels. Line art is not drawn to scale.

Cathedral doors less than 27" wide that have a vertical rail splitting the top opening will have a 2 1/2" drop.

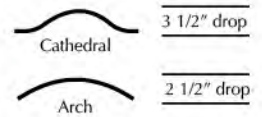

SL-33-C



SL-42-C

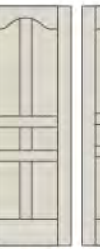

SL-62-C

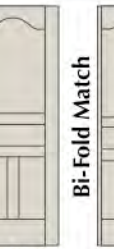

SL-43-C



Bi-Fold Match

SL-33-BF-C



SL-20-C



SL-35-C



SL-36-C



SL-40-C

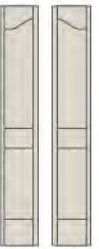

Bi-Fold Match

SL-20-BF-C



SL-21-C



SL-34-C



SL-46-C



Bi-Fold Match

SL-21-BF-C



SL-20-A



SL-35-A



SL-36-A



SL-40-A



SL-40-A



Bi-Fold Match

SL-20-BF-A



Made in USA

All doors labeled as SL



SL-50-A

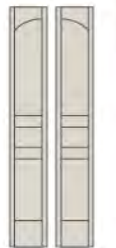

SL-50-BF-A



SL-50-C



SL-50-BF-C



SL-60-C



SL-60-BF-C



SL-89-A



SL-45-BF-A



SL-89-C



SL-45-BF-C



SL-60-A



SL-60-BF-C



Please contact us for louver door options

French Doors and Sidelights



SL-80



SL-8015



SL-8010



SL-809C



SL-8601



SL-8012-3W4H



SL-3401



SL-80 10LVG



SL-8018



SL-8412



SL-80 15LVG



SL-8612



SL-806C



SL-806-OS



SL-8005



SL-34-3L



SL-8012-2W6H



SL-3403



SL-64



SL-65



SL-68



SL-2001



SL-3003



SL-4301



SL-4504



SL-5205



SL-646



SL-649



SL-649C



SL-FS1



SL-FS2



SL-FS5



SL-FS6



SL-ES1



SL-ES3



SL-ES3C



SL-LS1



SL-LS4

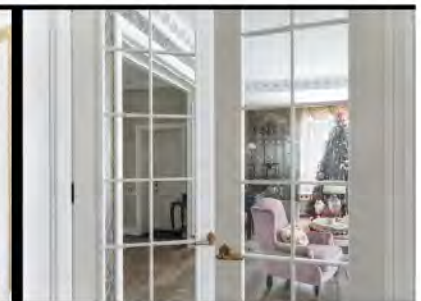



SL-20 RUSTIC MAPLE



SL-20-A KNOTTY ALDER*
KA



KNOTTY PINE
6-PNL* DH



SL-20 KNOTTY CEDAR

*Stock items



KNOTTY PINE
SL-20-VA



PANTRY
SL-KPT



Door Specifications

Hinge location from top of door to top of hinge

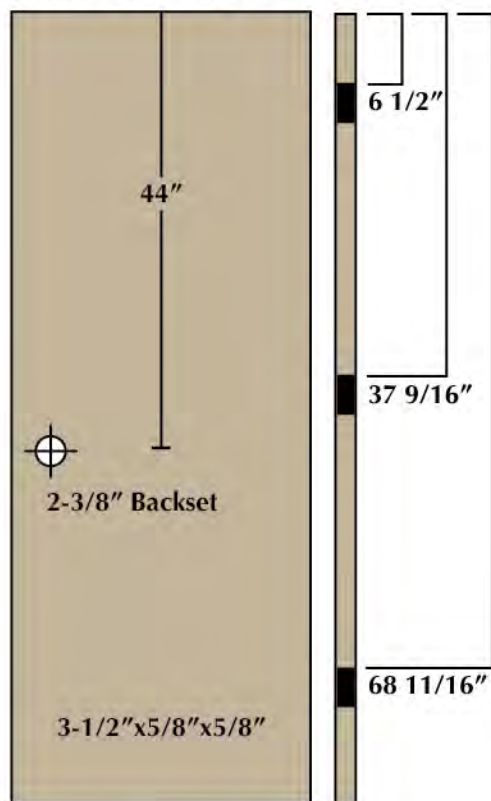

Handing Options

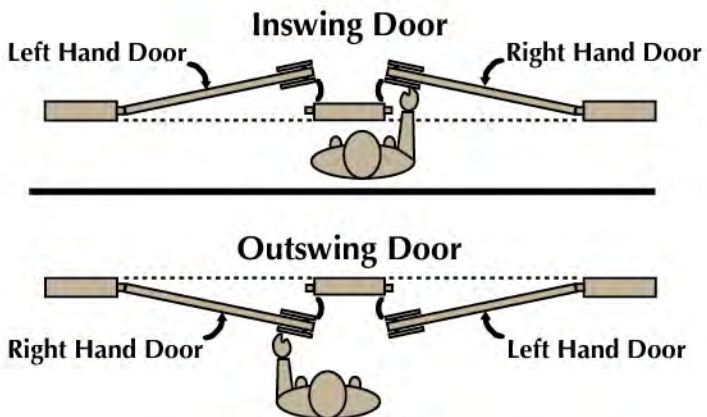

Pantry Door Options

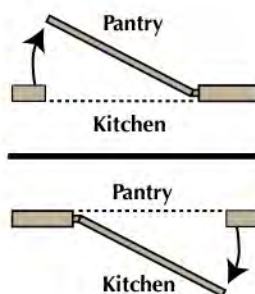

Jamb Options

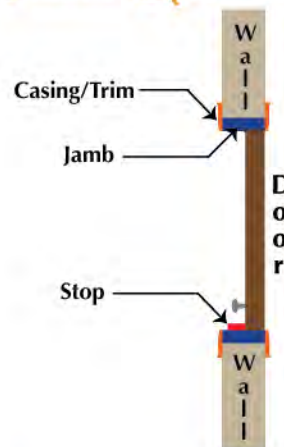

Stop Options

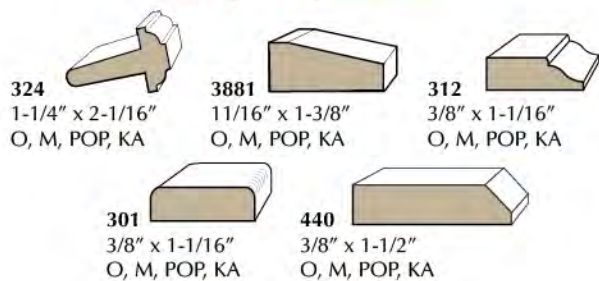

Softwood options on page 16

Glass Options

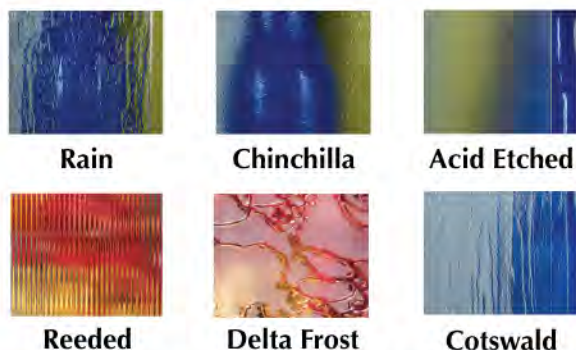

More options are available. See www.kochandco.com

Hinge Options



*Solid core doors have ball bearing hinges and hollow core have plain bearing hinges.

Door Toppers

Doors



F1855

F1856

F1857

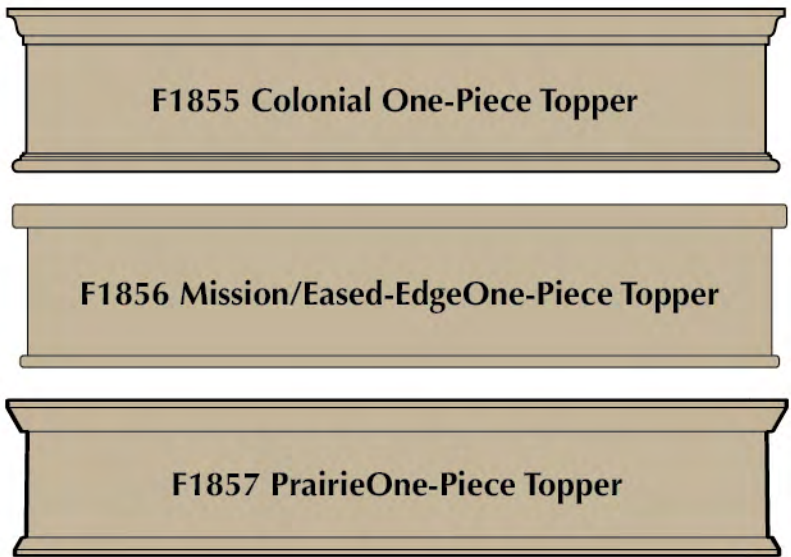

F1855 Colonial One-Piece Topper

F1856 Mission/Eased-Edge One-Piece Topper

F1857 Prairie One-Piece Topper

All styles: 1-1/4" x 5-1/4"

By adding crown or other mouldings to S4S, possibilities are truly endless!





Built-Up Pockets 1750 Series 150 lb. & 250 lb. Pocket Door

Hardware specifications:

- For installation of pocket or bi-parting doors up to 4' wide, 1" to 1-3/8" thick panels weighing up to 150 lbs. each and up to 8' high
- Heavy gauge, steel stiffener reinforces split jambs
- Four large 1" wheels for easy rolling action
- Easy to install feature makes installation a "snap"
- Supports panels weighing up to 150 lbs.
- Easy adjustment after installation
- V-groove jump proof aluminum track
- Opening width equals door width multiplied by 2, add 2"
- For Bi Part: Sum of 2 doors multiplied by 2, add 2"
- For 6' 8" Door: Height equals 84" from finished floor
- For 7' 0" Door: Height equals 88" from finished floor
- For 8' 0" Door: Height equals 100" from finished floor
- Built-Ups can be ordered in 6'8", 7'0", or 8'0" door height
- PDFC150N conforms to ANSI A156.14 type D8681
- Cross Reference: Stanley 1750, Cox 15-200, Grant 7000 Series, Hanger 9601/9701, Johnson 100, Lawrence 506/580 track, Sterling 1601 Series

Complete set consists of:

1 Track, 1 pair of Hangers, 2 Guides, 1 Bumper and 1 Wrench

Upgrade available

250 lb. heavy duty hardware has four large 1" ball bearing wheels for easy rolling action

Soft close hardware available

Standard sizes of 6/8 tall in Stock.

Call for lead time and price on custom sizes.

Hanger Diagram

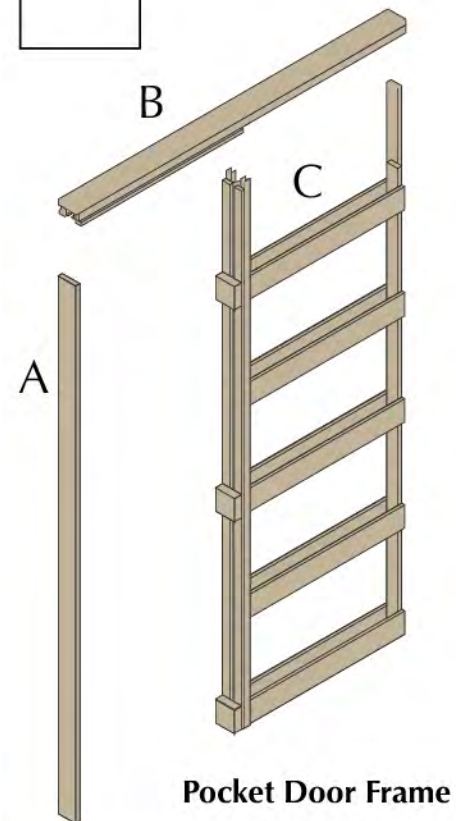
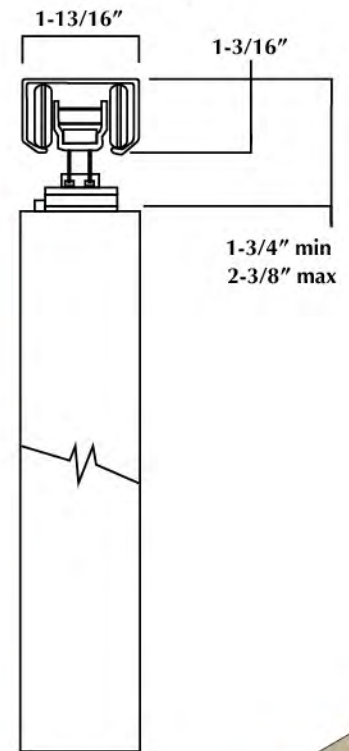

Pocket Door Frame

A - Face jamb

B - Top track

C - Pre-assembled pocket frame

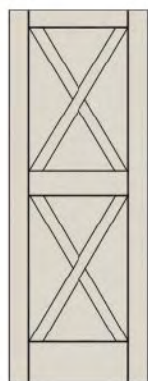

SL-20-DBLXBAR



SL-20-KBAR

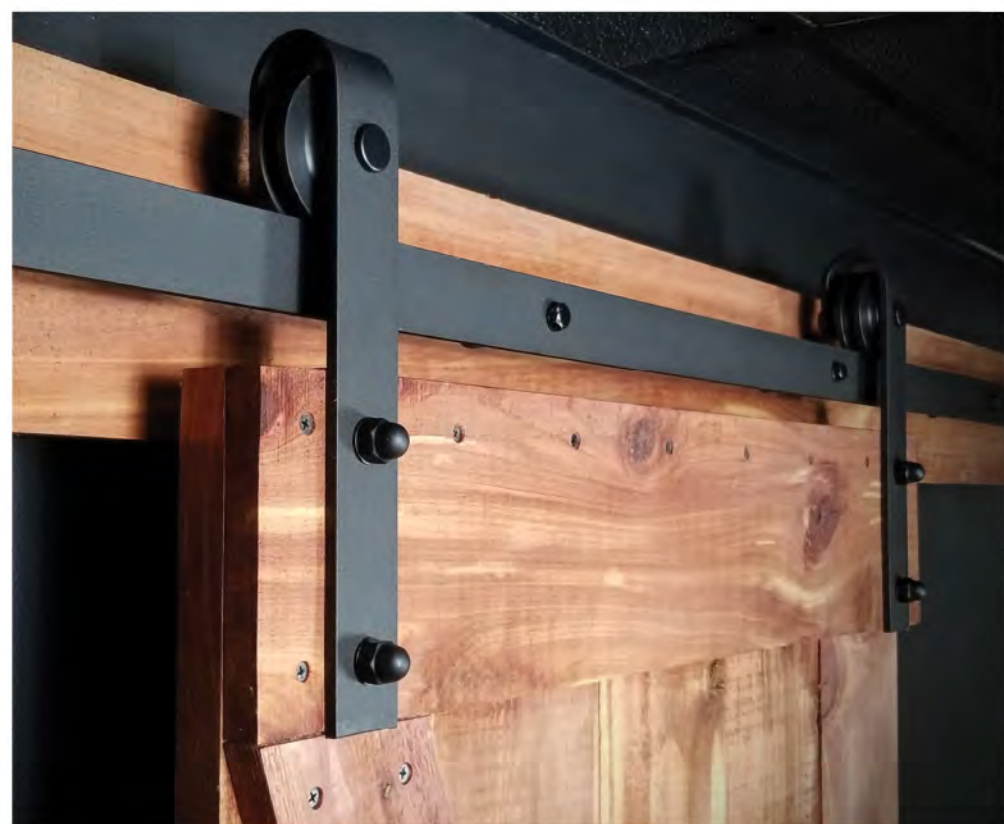

J-Style Strap System

- Load capacity of max. 200 lbs per door
- Precision bearing rollers
- Pre-drilled track with 16" centers
- Top mount design



SL-10-V-ZBAR

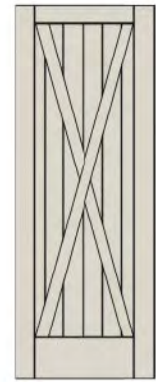

SL-10-V-XBAR





Manion's
Millwork

Mouldings

Hardwood Casing

IN STOCK



F113 - 1/2" x 2-1/4"
O, M, POP



F115 - 1/2" x 2-1/4"
O, M, POP



F118 - 1/2" x 2-1/4"
O, M, POP, KA



F156 - 3/8" x 2-1/4"
O, M, POP, KA



F1573 - 9/16" x 3-1/4"
O, M, POP, KA



F134 - 9/16" x 3-1/4"
O, M, POP, KA



F100 - 9/16" x 2-1/4"



F104 - 11/16" x 2-1/4"



F106 - 3/4" x 2-1/4"



F121 - 5/8" x 2-1/2"



F107 - 9/16" x 2-1/4"



F110 - 9/16" x 2-1/4"



F111 - 9/16" x 2-1/4"



F114 - 1/2" x 2"



F120 - 3/4" x 2-1/2"



F119 - 1/2" x 1-5/8"



F1420 - 3/4" x 3-1/4"



F1412 - 3/4" x 3-1/4"



F132 - 11/16" x 3-1/4"



F131 - 11/16" x 3-1/4"



F1432 - 3/4" x 4"

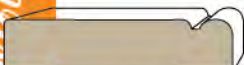

F1430 - 3/4" x 3-1/4"



F1410 - 5/8" x 3-1/2"



F140 - 1" x 4-1/2"



F130 - 11/16" x 3-1/2"



F136 - 1/2" x 3-1/4"

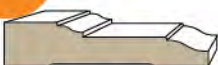

F1422 - 3/4" x 3-1/2"



F1644 - 11/16" x 3-1/4"



F1634 - 9/16" x 3-1/4"



F1514 - 11/16" x 3-1/4"

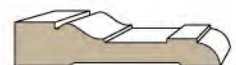

F1422 - 3/4" x 3-1/2"



F1614 - 11/16" x 3-1/4"



F161 - 11/16" x 3-1/4"



F178 - 9/16" x 2-3/8"



F160 - 11/16" x 3-1/4"



F169B - 3/8" x 1-1/2"



F126 - 11/16" x 2-1/2"



F1624 - 11/16" x 3-1/4"



F1450 - 1-1/16" x 4-1/2"



F162 - 11/16" x 5-1/2"



F1654 - 11/16" x 3-1/4"



F174 - 9/16" x 2-3/8"



F169A - 3/8" x 1-1/2"



F169 - 11/16" x 3-1/4"



F163 - 11/16" x 3-1/4"

For more options
visit www.ferche.com

See Page 16 for Soft Woods



CCB312T
3/4" x 3-1/2"



CCB3T
3/4" x 3"



CCB212T
3/4" x 2-1/2"

Mouldings

Flat Casing

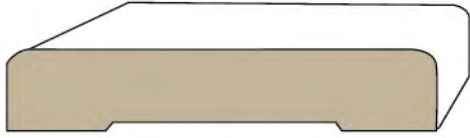

PROFILE #	DIMENSIONS	PROFILE #	DIMENSIONS	PROFILE #	DIMENSIONS
F156	O, M, POP, KA 3/8" x 2-1/4"	F1543	1/2" x 3"	F159	11/16" x 2-1/2"
F1573	O, M, POP, KA 9/16" x 3-1/4"	F1544	1/2" x 3-1/4"	F1582	11/16" x 3"
F1561	7/16" x 2-1/2"	F1545	1/2" x 3-1/2"	F153	11/16" x 3-1/4"
F1562	7/16" x 3"	F157	9/16" x 2-1/4"	F1584	11/16" x 3-1/2"
F1563	7/16" x 3-1/4"	F154	9/16" x 2-1/2"	F1585	11/16" x 4"
F1564	7/16" x 3-1/2"	F1572	9/16" x 3"	F1586	11/16" x 4-1/2"
F1541	1/2" x 2-1/4"	F1574	9/16" x 3-1/2"	F1587	11/16" x 5-1/2"
F1542	1/2" x 2-1/2"	F158	11/16" x 2-1/4"	F1588	11/16" x 7-1/4"

Brick Mould / Backbands

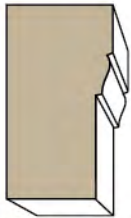

F170 - 1-1/16" x 2"

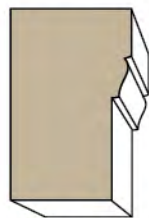

F171 - 1-1/4" x 2"

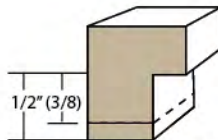

F1910 - 3/4" x 3/4"
F1915 - 3/4" x 7/8"

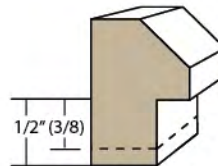

F1911 - 3/4" x 1"
F1916 - 3/4" x 1-1/8"

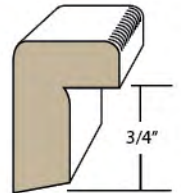

F194 - 3/4" x 1-1/16"

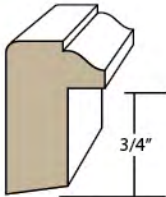

F195 - 11/16" x 1-1/16"

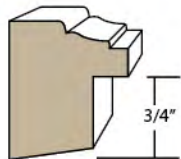

F196 - 1-1/4" x 1-1/16"



F1912 - 1" x 1-5/16"



F1932 - 1-1/8" x 1 1/2"

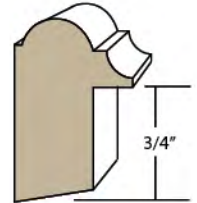

F197 - 3/4" x 1-3/16"

Flat Casing / No Eased Edges



F1814 - 3/8" x 3-1/4"



F1815 - 1/2" x 3-1/4"

Mouldings

Hardwood Baseboards

Mouldings

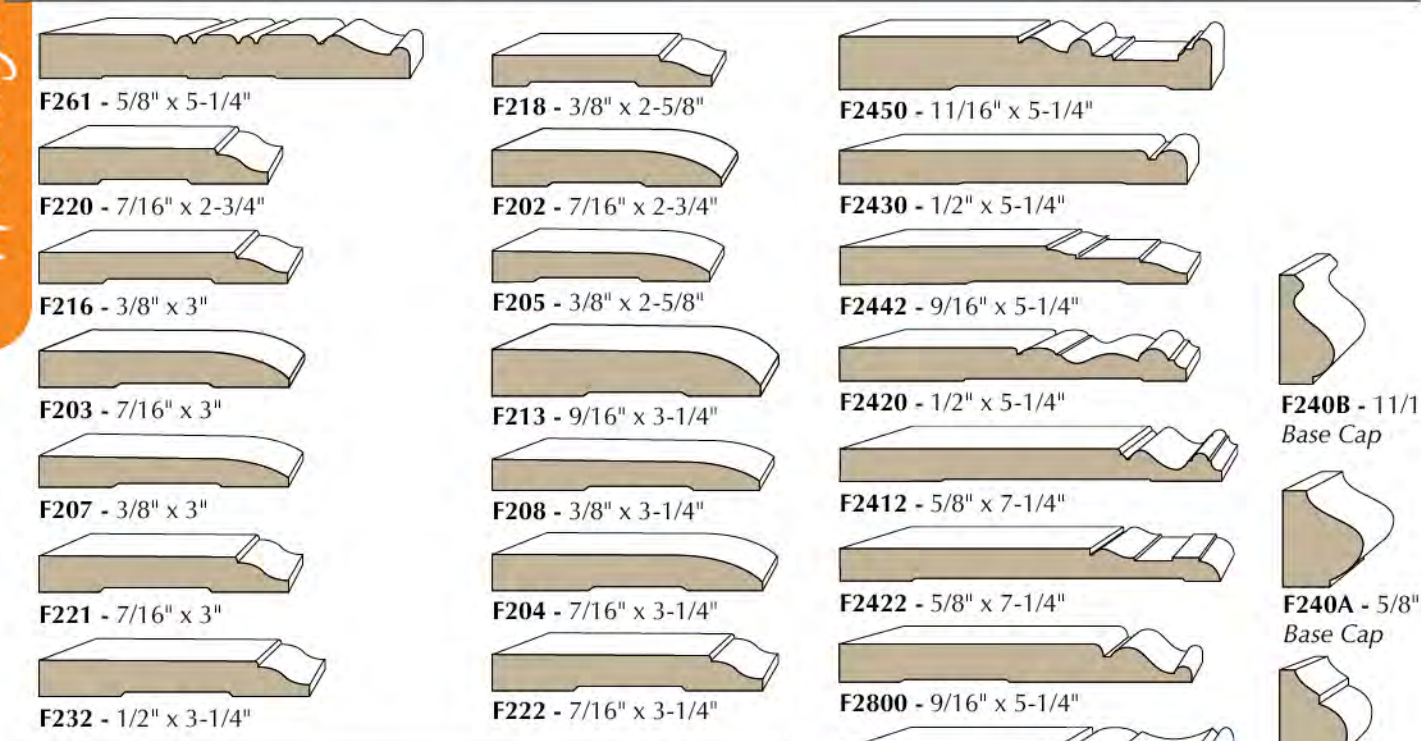
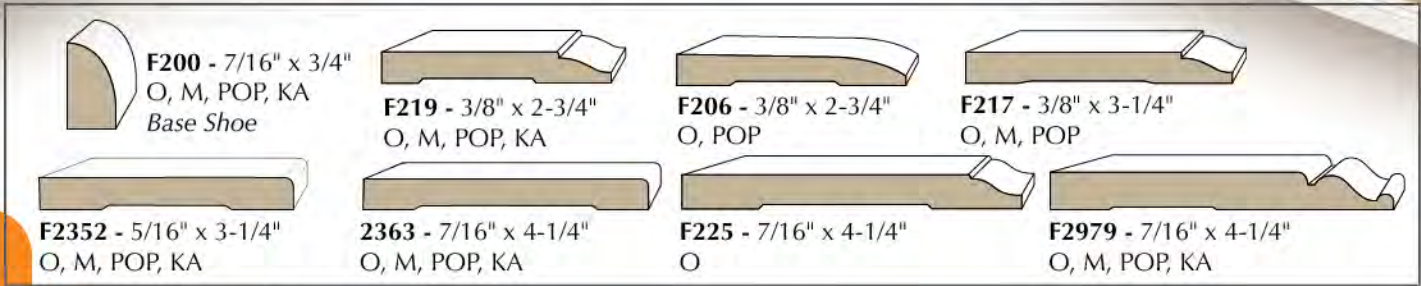

Base / Eased One Edge



PROFILE #	DIMENSIONS	PROFILE #	DIMENSIONS	PROFILE #	DIMENSIONS
F2352	O, M, POP, KA 5/16" x 3-1/4"	F237	7/16" x 3"	F2439	9/16" x 3-1/2"
F2363	O, M, POP, KA 7/16" x 4-1/4"	F238	7/16" x 3-1/4"	F2433	9/16" x 4-1/4"
F2350	3/8" x 2-3/4"	F2364	7/16" x 5-1/4"	F2434	9/16" x 5-1/4"
F2351	3/8" x 3"	F243	1/2" x 3-1/4"	F2532	11/16" x 3-1/2"
F2353	3/8" x 4-1/4"	F293	1/2" x 5-1/4"	F2533	11/16" x 4-1/4"
F2354	3/8" x 5-1/4"	F2440	9/16" x 2-3/4"	F2534	11/16" x 5-1/4"
F236	7/16" x 2-3/4"	F2431	9/16" x 3"	F2535	11/16" x 7-1/4"

See Page 16 for Soft Woods

Pine and Fir Mouldings

All In Stock

Mouldings

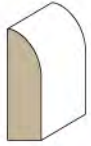

STOP
845
7/16" x 1-5/8"



STOP
857
3/8" x 1-1/4"

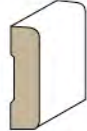

STOP
L 887 E2E
3/8" x 1-1/4"



STOP
947
3/8" x 1-1/4"



QUARTER ROUND
106
11/16" x 11/16"
108
1/2" x 1/2"
110
1/4" x 1/4"



BASE SHOE
126
1/2" x 3/4"

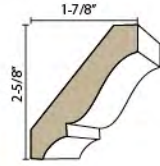

CROWN
L 51
9/16" x 3-1/4"



CHECK STOP
254
1/2" x 3/4"



OUTSIDE CORNER
204
1-5/16"
205
1-1/8"
206
3/4"



SCREEN MOULDING
142
1/4" x 3/4"

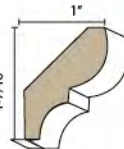

BED MOULDING
74
9/16" x 1-3/4"

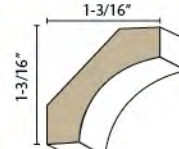

COVE
85
9/16" x 1-3/4"



COVE
100
11/16" x 11/16"

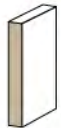

LATTICE
L 265
1/4" x 1-3/4"
L 267
1/4" x 1-3/8"
L 268
1/4" x 1-1/8"



CLOSET POLE
L 233
1-1/4" Full Round
Fir



WALL RAIL
231
1-1/2" x 1-11/16"
Fir

348 Boards

3/4" x 5-1/2" x 8'
3/4" x 7-1/4" x 8'
3/4" x 11-1/4" x 8'



Baseboard



L 634
7/16" x 3"



L 724
7/16" x 3"



L 433 E2E
7/16" x 3-1/4"



324
11/16" x 2-1/4"



473 E2E
9/16" x 2-1/4"



366
11/16" x 2-1/4"

Primed Mouldings

All In Stock



FJ BRICK
180
1-1/4" x 2"

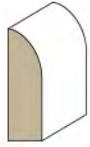

STOP
845
7/16" x 1-5/8"

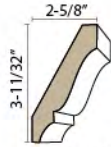

CROWN
L 48
9/16" x 4-1/4"



STOP
L 887 E2E
3/8" x 1-1/4"



BULLSEYE
ROSETTE
1400
7/8" x 2-3/4"
1402
7/8" x 3-3/4"



STOP
947
3/8" x 1-1/4"



FJ HOOK
STRIP 432
9/16" x 3-1/2"

Casing



356
11/16" x 2-1/4"



444
11/16" x 3-1/4"



E412 E2E
11/16" x 3-1/2"

Baseboard



L 634
7/16" x 3"



P 813
9/16" x 5-1/4"



L 514 E1E
9/16" x 5-1/4"



S4S Boards

3/4" x 3-1/2" x 16'

3/4" x 5-1/2" x 16'

3/4" x 7-1/4" x 16'



Mouldings

Solid S4S Boards and Misc. Mouldings

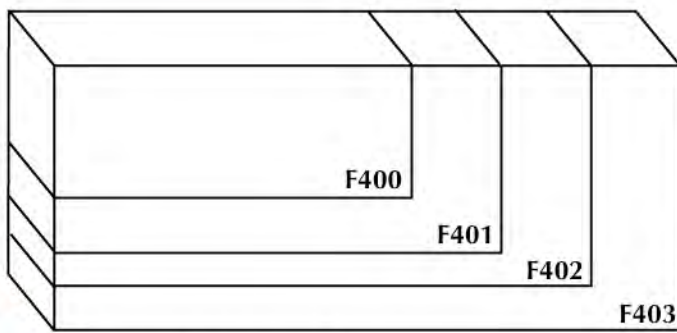

F400 - FOR 3/4" THICK
F401 - FOR 1-1/16" THICK
F402 - FOR 1-1/4" THICK
F403 - FOR 1-1/2" THICK
 WIDTHS UP TO 11-1/4"

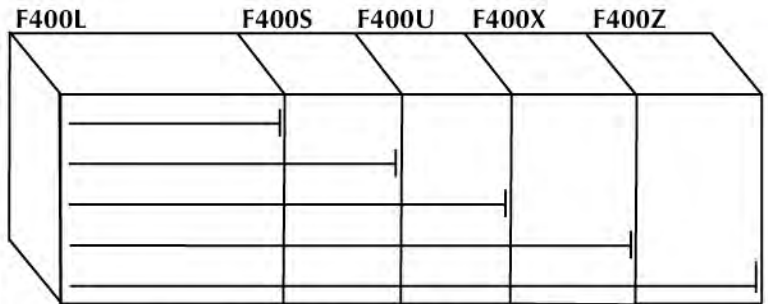

F400S - 3/4" x 5-1/2" O, M, POP, KA
F400U - 3/4" x 7-1/4" O, M, POP, KA
F400X - 3/4" x 9-1/4" O, M, POP, KA
F400L - 3/4" x 3-1/2"
F400Z - 3/4" x 11-1/4"

Mouldings

Mull Center



F500A - 1/4" x 1-1/4" O, M, POP, KA
F500D - 1/4" x 2" O, M, POP, KA
F500J - 1/4" x 4" O, M, POP, KA

F500B - 1/4" x 1-1/2"
F500C - 1/4" x 1-3/4"
F500F - 1/4" x 2-1/2"

F500H - 1/4" x 3"
F500I - 1/4" x 3-1/2"
F500K - 1/4" x 4-1/2"

F500L - 1/4" x 5"
F500N - 1/4" x 6"

Outside Corner



F651
 3/4" x 3/4"
 O

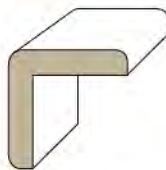

F652
 1-1/16" x 1-1/16"
 O

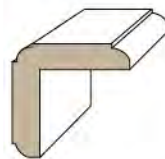

F655
 1-1/16" x 1-1/16"

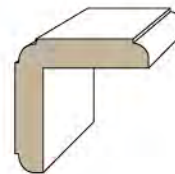

F656
 1-5/16" x 1-5/16"



Quarter Round

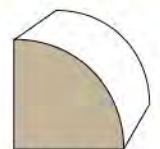

F661 - 3/4" x 3/4"
 O

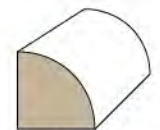

F662 - 1/2" x 1/2"

Inside Corner



F667 - 3/4" x 3/4"



F660 - 9/16" x 1-1/8"

Crowns and Coves

Crowns

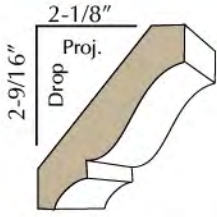

F610
11/16" x 3-7/16"
O, M, POP, KA

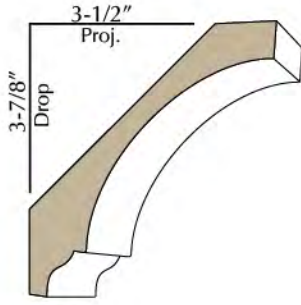

F613
1-1/16" x 5-3/8"

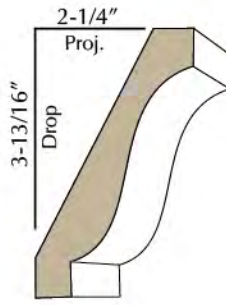

F612
3/4" x 4-9/16"

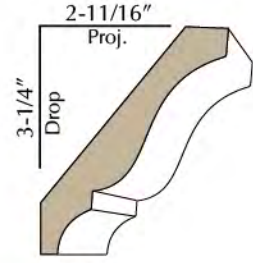

F614
11/16" x 4-1/4"



F608
9/16" x 2-1/4"

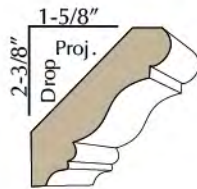

F618
3/4" x 3"

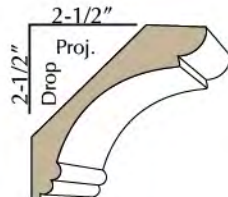

F611
3/4" x 3-5/8"

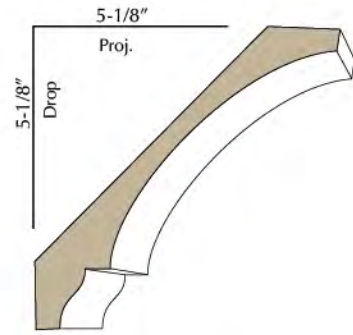

F641
1-1/16" x 7-1/4"

Coves



F600 - 1/2" x 1/2"



F601 - 3/4" x 3/4"
O, M, POP, KA



F602 - 3/4" x 1-1/4"

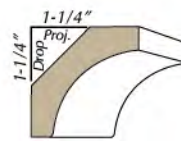

F605 - 9/16" x 1-3/4"

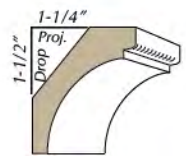

F606 - 9/16" x 2"

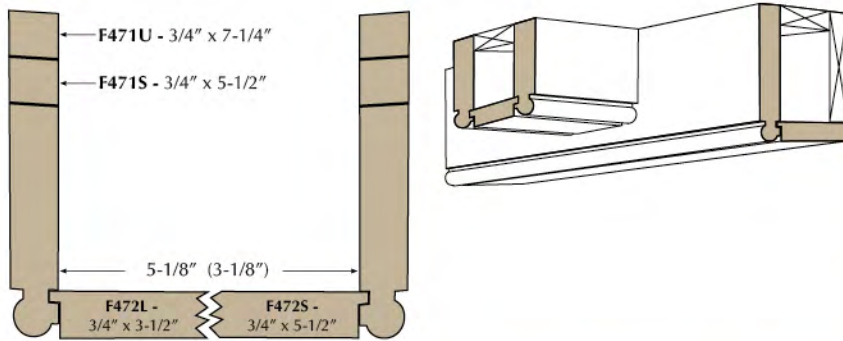

Trim Kits

Trim your windows, trim your time!

Benefits of Trim Kits:

- Completely assembled extension jamb with your choice of casing applied utilizing raw or finished materials
- Q-Lon weather stripping pre-applied (optional)
- No field cutting of interior trim
- Tight miters every time
- Can be pre-finished prior to installation
- Custom sizing and jamb depths available
- For vinyl or aluminum windows
- Huge labor savings
- Up to 16" jamb depth and 12' lengths on some species
- Also available in patio door kits
- Available 8', 10' and 12' pieces
- 5-15/16" available in white vinyl, poplar, maple, oak, alder and pine
- 16" available in white vinyl, poplar, maple and oak





Manion's 

Millwork

Stair Parts

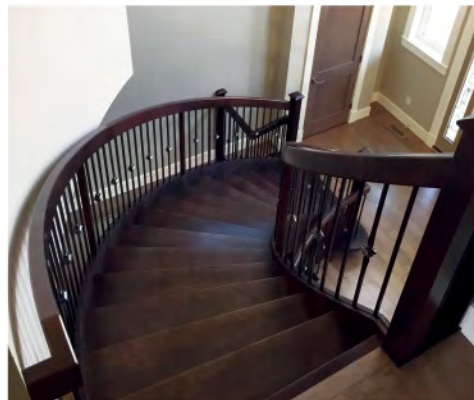
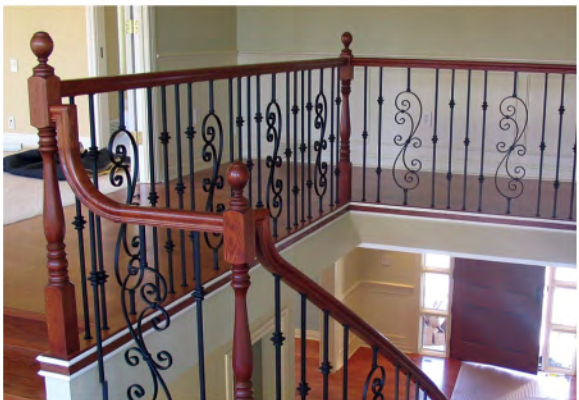
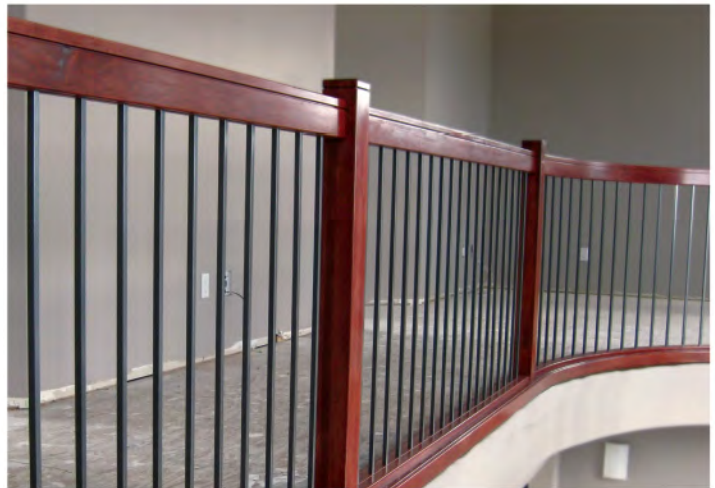

1. Volute with Easement
2. Turn-Out Easement with Newel Cap
3. Dowel Top Newel Post
4. Goose Neck (1 riser)
5. Goose Neck with L.H. Quarter Turn
6. Ball Top Newel Post
7. Half Newel Post
8. Up Easement
9. Goose Neck with Newel Cap
10. Rail Drop
11. Handrail Bracket
12. Level Quarter Turn
13. Baluster 36"

14. Baluster 42"
15. Goose Neck Quarter Turn
16. Level Quarter Turn with Newel Cap
17. Newel Cap with 2 Rail Outlets
18. Oval Rosette
19. Sub Rail c/w Fillet

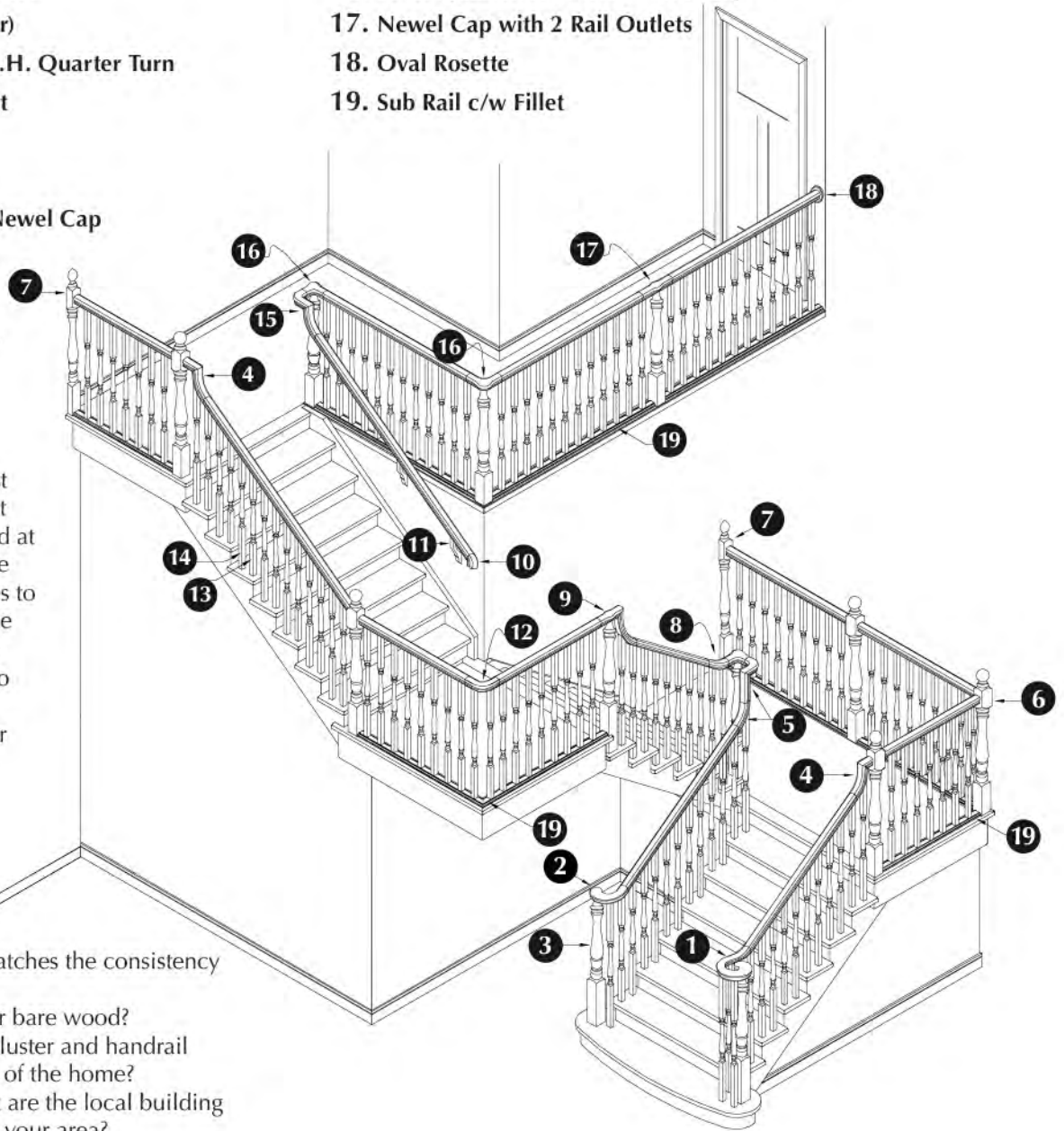

Stairs are one of the most architecturally significant features of the home, and at the same time, one of the most challenging features to design. To help you in the design process, here are several things to take into consideration when choosing the correct stair system for your home:

- Is the stair "Post-to-Post" or "Over-the-Post"?
- What specie of wood matches the consistency of the home?
- Are the stairs carpeted or bare wood?
- What turning, newel, baluster and handrail profiles match the theme of the home?
- Most importantly - What are the local building codes regarding stairs in your area?



Newels



4001

3-1/2" x 56"
S4S Newel
w/Chamfer
O, M, POP, KA, KP



4111

3" x 56"
S4S Newel
w/Chamfer
O, M, POP, KA, KP



4075

3-1/2" x 56"
Box Newel
O, M, POP, KA, KP



4075S

4-1/2" x 56"
Box Newel and Sleeve
O, M, POP, KA, KP



4091



4091TFP

4091
6-1/4" x 56"
Box Newel and Sleeve
O, M, POP, KA, KP

4091TFP
6-1/4" x 56"
Box Newel and Sleeve
w/Traditional Flat Panel
O, M, POP, KA, KP



3042-56

3-1/2" x 56"
Stockbridge
Newel
w/Acorn Top
O



3045-56

3-1/2" x 56"
Stockbridge
Newel
w/Acorn Top
O

Stair Parts



Mushroom Top

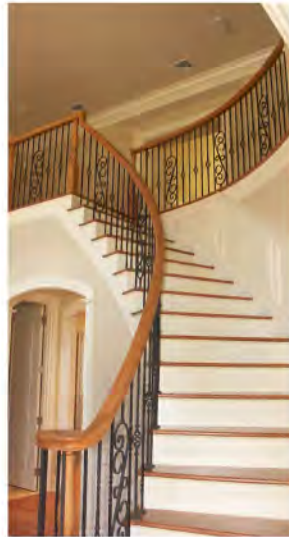

4040M

3" x 48"
O, M, POP



4042M

3" x 54"
O, M, POP



4045M

3" x 59"
O, M, POP



4500

3-1/2" x 48"
Starting Newel
w/Ball Top
O, M, POP, KA, KP



4502

3-1/2" x 56"
Starting Newel
w/Ball Top
O, M, POP, KA, KP



4503

3-1/2" x 56"
Landing Newel
w/Ball Top
O, M, POP, KA, KP

Balusters

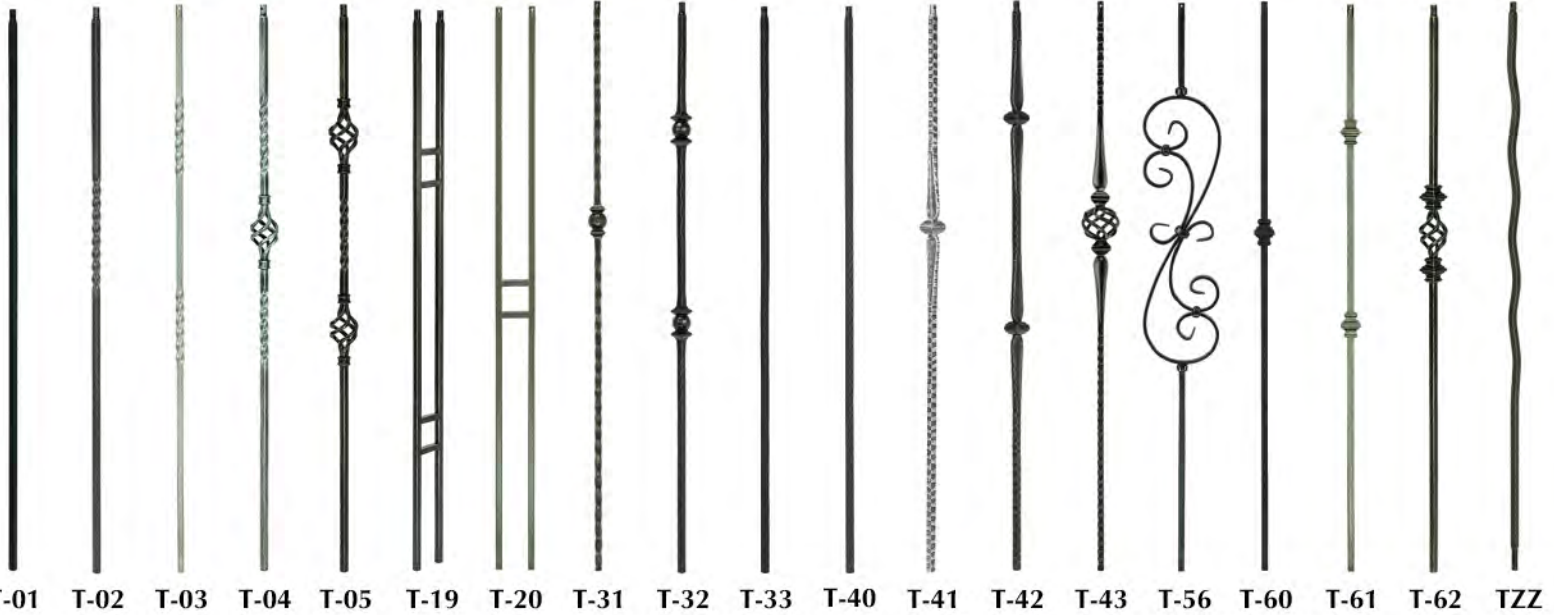

All profiles in stock Satin Black and Rubbed Copper



Also available in:
 -Silver Vein
 -Copper Vein
 -Pewter
 -Rubbed Bronze
 -Nickel
 -Antique Nickel
 -Wrinkle Black



SH900
Flat Shoe with Screw
 -Rubbed Copper
 -Satin Black



SH904
Slant Shoe with Screw
 -Rubbed Copper
 -Satin Black



SH901
Flat Shoe H with Screw
 -Rubbed Copper
 -Satin Black



SH905
Slant Shoe H with Screw
 -Rubbed Copper
 -Satin Black

Wood Balusters available in 1-1/4" and 1-3/4"



5060
 O, M, POP,
 KA, KP, PR



5360
 O, M, POP,
 KA, KP, PR



5141
 O, M, POP, PR



5015
 O, M, POP, PR



2015
 O



2005
 O



5005
 O, M, POP,
 KA, KP, PR

Stair Parts

Handrail Components



Brand X
Finger Joint



Manion's
Lightning Bolt
Jointed
(less obtrusive)



6210
Handrail - No Plow
2-5/8" x 2-3/8"
O, M, POP, KA, KP



6210P
Handrail 1-3/4" Plow
w/ 6007 Fillet
2-5/8" x 2-3/8"
O, M, POP, KA, KP



6010P
Handrail 1-1/4" Plow
w/ 6107 Fillet
2-1/4" x 2-3/8"
O, M, POP, KA, KP



6010
Handrail - No Plow
2-1/4" x 2-3/8"
O, M, POP, KA, KP



901
Wall Rail
1-5/8" x 1-3/4"
O, M, POP, KA, KP



6770P
Handrail 1-1/4" Plow
w/ 6107 Fillet
2-1/4" x 1-5/8"
O, M, POP, KA, KP



6770
Handrail - No Plow
2-1/4" x 1-5/8"
O, M, POP, KA, KP



6770P1
Handrail 1-3/4" Plow
w/ 6007 Fillet
2-1/4" x 1-5/8"
O, M, POP, KA, KP



6007
Fillet 1-3/4"
1-3/4" x 3/8"
O, M, POP, KA, KP



6107
Fillet 1-1/4"
1-1/4" x 3/8"
O, M, POP, KA, KP



6207
Fillet 1/2"
1/2" x 3/8"
O, M, POP, KA, KP



6002S
Shoe Rail - Plow 1/2"
w/ 6207 Fillet
2-1/2" x 3/4"
O, M, POP, KA, KP



6000S
Shoe Rail - Plow 1-1/4"
w 6107 Fillet
2-1/2" x 3/4"
O, M, POP, KA, KP



6001S
Shoe Rail - Plow 1-3/4"
w/ 6007 Fillet
2-1/2" x 3/4"
O, M, POP, KA, KP



WSW609R/L
7" Center to Center



HRBBSOAK
1-1/2" x 1-3/4" x 5-1/2"



HRBRACKOD
1-3/4" x 4-1/4" x 10-3/8"



HRBRACKOA
1-1/4" x 3-1/2" x 7-1/2"



3001
1" Flat Tapered Plug
O, M, POP, KA



30012
1/2" Flat Tapered Plug
O, M, POP, KA



3012
1/2" Buttons
O, M, POP, KA



7037
Oval Rosette
4" x 5-3/4"
O, M, POP,
KA, KP



7033
Rectangular Rosette
4-1/4" x 6"
O, M, POP,
KA, KP

3003
Handrail Bracket
In-Stock
- Satin Black
- Satin Nickel
- Bright Brass
- Antique Brass
- Colonial Bronze



Stair Parts

Treads and Risers



8070MR-RH-48
Mitered Tread RH
 1-1/32" x 11-1/2" x 48"
 O, M

8070MR-LH-48
Mitered Tread LH
 1-1/32" x 11-1/2" x 48"
 O, M

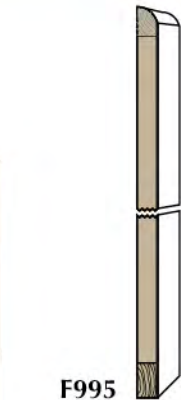

F995
Skirt Board
 7/16" x 9-1/4"
 10', 16' 18'
 O, M, POP, KA
 10', 16' KP



F996
Skirt Board
 7/16" x 9-1/4"
 10', 16', 18'
 O, M, POP, KA
 10', 16' PR



8070
Tread
 1-1/32" x 11-1/2"
 60" x 11-1/2" O
 48" x 11-1/2" O, M



8078
Riser 3/4" x 7-1/2"
 60" x 7-1/2"
 O
 48" x 7-1/2"
 O, M

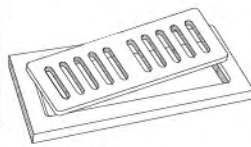

HAR310SP
 3" x 10"
 Surface Mount
 with Regulator



F988
Landing Tread
 1-1/16" x 5-1/2"
 Random Lengths
 O, M, POP, KA



8171-RH
Tread Cap RH
 1/2" x 5-1/4" x 17"
 O, M, POP, KA



CARE16
 8" x 16"
 Eased Edge 3 sides

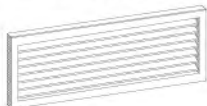

CARE24
 8" x 24"
 Eased Edge 3 sides



CARE32
 8" x 32"
 Eased Edge 3 sides

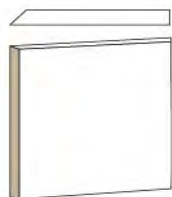

8176
Riser Cap
 1/2" x 5-1/4"
 O, M, POP, KA



8172
Tread Cap
 1/2" x 5-1/4"
 O, M, POP, KA



8171-LH
Tread Cap LH
 1/2" x 5-1/4" x 17"
 O, M, POP, KA

Stair Parts

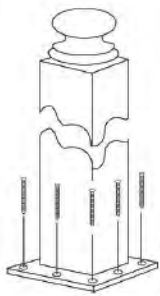

**FU-6282
EZLOCK Fastener**

Use to mount 3" to 3 1/2" newel posts on finished and unfinished floor surfaces. Mounting plate has holes for center or off-center post placement.

Package includes:

- 1 - 3/16" x 4-5/8" x 4-5/8" steel plate
- 13 - #10 x 2-1/2" wood screws



**FU-6286
Dowel Lock Fastener**

Use to mount round newel posts and balusters on starting steps with volutes or turnouts. Simple method to mount the post after the starting step is installed – no access from below is needed. Attach balusters with dowel screws to avoid stress cracks on radius edge.

Package includes:

- 1 - 1/4" x 3 1/2" dowel screw with center stop
- 6 - 1/4" x 2 1/2" dowel screws

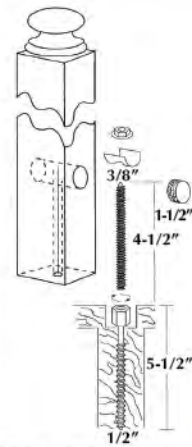

**FU-6284
Thread Lock Fastener**

Use to mount newel posts on finished and unfinished floor surfaces. The split bolt system makes it easy for universal applications.

Package includes:

- 1 - 1/2" x 5 1/2" with 3/8" ID hex head
- 1 - 3/8" x 5" threaded rod
- 1 - 3/8" serrated flange hex nut
- 1 - Steel radius washer
- 1 - 1 1/2" reversible oak/beechn wood plug



**FU-6287
Mini Lock Fastener 2/PACK**

Use to fasten handrail to newel post for a fully concealable installation. Use to join mitered/angled railings and other fittings for factory tight joints.

Package includes:

- 2 - 1 1/4" diameter x 1/8" hardened steel plate
- 2 - #8 x 1 1/4" pan head screws
- 2 - #6 x 1" flat head screws

The KeyLOCK™ Newel Post Fastener is fully concealable. No extra moulding or wood plug is required. Use on finished floor surfaces, stairs, nosing, ceramic tile, and concrete. Designed to tightly draw two members together as the lag bolt head slides down the keyhole slot.

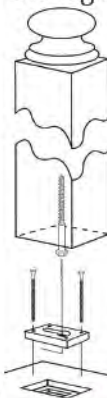

Package includes:

- 1 - 2-5/8" x 1-7/8" x 3/8" steel plate
- 1 - 3/8" x 5" lag bolt
- 4 - #10 x 3 1/2" wood screws



**FU-6283
Keylock Fastener**

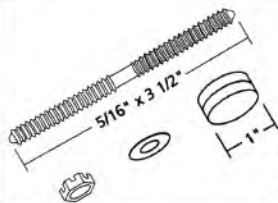

**FU-6288
Rail Bolt Fastener**



FU-6281

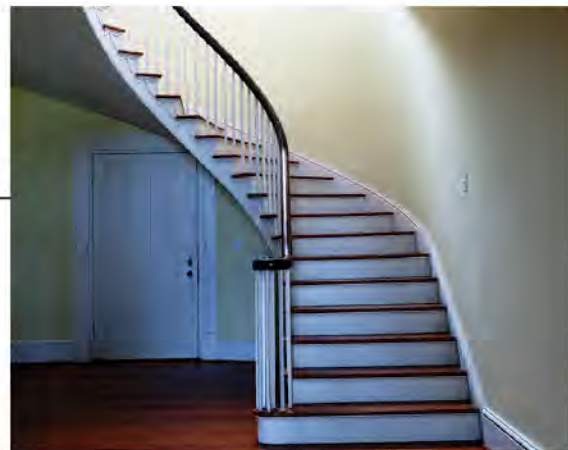
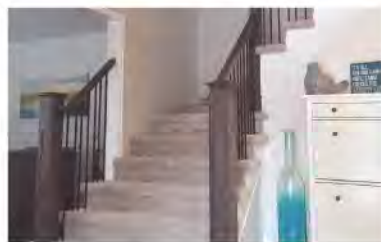

Standard Pre-Finish Colors on Oak

				
#704 Light Oak	#705 Golden Oak	#706 Golden Hickory	#707 Dark Oak	#708 Antique
				
#709 Cinnamon	#710 Country Pine	#711 Traditional Cherry	#712 American Walnut	#713 Cherry
				
	#792 Fawn	#793 Springbrook	#794 Fruitwood	

Standard Pre-Finish Colors on Maple

				
#820 Light Oak	#821 Golden Oak	#822 Golden Hickory	#823 Dark Oak	#824 Antique
				
#825 Cinnamon	#826 Country Pine	#827 Traditional Cherry	#828 American Walnut	#829 Cherry

Standard Pre-Finish Colors on Poplar

				
#1020 Light Oak	#1021 Golden Oak	#1022 Golden Hickory	#1023 Dark Oak	#1024 Antique
				
#1025 Cinnamon	#1026 Country Pine	#1027 Traditional Cherry	#1028 American Walnut	#1029 Cherry

Standard Pre-Finish Colors on Knotty Alder

				
#920 Light Oak	#921 Golden Oak	#922 Golden Hickory	#923 Dark Oak	#924 Antique
				
#925 Cinnamon	#926 Country Pine	#927 Traditional Cherry	#928 American Walnut	#929 Cherry

Standard Pre-Finish Colors on Pine

				
#1120 Light Oak	#1121 Golden Oak	#1122 Golden Hickory	#1123 Dark Oak	#1124 Antique
				
#1125 Cinnamon	#1126 Country Pine	#1127 Traditional Cherry	#1128 American Walnut	#1129 Cherry

We also offer custom color matches to match your existing millwork.

Featured Brands

Manion's Millwork proudly features these great brands!



www.kochcabinet.com

**FERCHE
MILLWORK**

www.ferche.com



www.empireco.com



GLOBAL**POINTE**

www.global-pointe.com



www.woodlandsupply.ca



www.sourcebp.com



MASONITE

Open to extraordinary.

www.masonite.com



www.stalliondoors.com

A & F WOOD PRODUCTS, INC.

www.afwood.com

PENROD

www.thepenrodcompany.com

Manion's

www.manionswholesale.com