

Metal Sales Product Catalog

Metal Roof & Wall Systems



Architectural
Commercial
Post Frame
Residential

MS Metal Sales™

THE METAL SALES DIFFERENCE

For more than 60 years, Metal Sales Manufacturing Corporation has earned a reputation as the premier provider of innovative metal building components and accessories. We've backed this reputation with the industry's largest professional sales and service team, supported by 21 branches located throughout the United States.

We offer a full line of exceptional quality metal roof and wall panels for agricultural, commercial, architectural, industrial and residential projects of every shape and size – new construction or retrofit.







But our technology and durable designs are only part of the story. Architects, contractors and installers appreciate the impeccable service from our highly trained professional staff, ready to answer any question, or help devise custom solutions to your building and energy saving needs.

- Serving the architectural, commercial, residential, industrial and agricultural markets for over half a century
- In-house engineering and design assistance available
- A wide selection of materials and finishes available, including MS Colorfast45®, MS Crinkle Finish, ColorFit40™, PVDF, Weathering Steel, Aluminum, Stainless Steel and Copper
- Over 100 profiles available with matching trim and accessories
- Metal panels contribute to LEED points
- 21 convenient locations nationwide, including Alaska
- Quoting and shipping projects worldwide
- Up to 45 year Finish Warranties available
- Panel testing including, UL 580, ASTM E 1592 and approvals including Miami-Dade County, Florida Building Code (FBC) 2023, ICC Evaluation Report, Texas Department of Insurance and Underwriters Laboratory (UL)
- 30 year Weather-Tight Warranty available (on select profiles) 
- Curving capabilities available – (see page 8)







Metal Sales is dedicated to leading the metal building component industry, by setting new standards for operating efficiency, product design, active service management and lasting value. We strongly believe that by investing in our corporation, we will ensure the best products and services for our customers, high job satisfaction for our employees and continued innovation and growth for our industry.

Profile Selection

STANDING SEAM PANELS

Magna-Loc 90.....	4	
Magna-Loc 180.....	4	
T-Armor Series™	5	
Seam-Loc 24®.....	6	
Snap-Loc 24	6	
Vertical Seam, Vertical Seam Plus	7	
Clip-Loc	7	

CONCEALED FASTENED PANELS

Image II™	8	
Mini-Batten, Curved Mini-Batten.....	9	
Maxi-Batten	9	
Board and Batten.....	10	
TLC Series.....	10,11	
Apex Series (CFWP)	12	
Contempra Series (CFWP).....	12	
Empire Line (CFWP)	13	
Soffit Panel	14	

EXPOSED FASTENED PANELS

T10 Series	15
7/8" Corrugated	16
5V-Crimp.....	16
IC72-Panel, V-Line 32	17
Low Rib Series	18,19
2" Rib Series.....	20
3" Rib Series.....	20
Deep Rib Series	21

METAL BUILDING PANELS

PBR-Panel, R-Panel.....	22
PBU-Panel, U-Panel.....	22
Pro-Panel II®.....	23
Classic Rib®.....	23
1.25" Corrugated	24
2.5" Corrugated	24
Strongpanel	25
DL-3 Panel.....	25
Bi-Rib, Delta Rib, Dual Rib	26

INSULATED WALL & ROOF PANELS

IMPowder Series™	27
------------------------	----

BUILDINGS & COMPONENTS

IMPACT Steel Building Systems.....	28
Self Storage Solutions.....	29
Secondary Framing	29
Retro-Master®.....	30
Roof Hugger® – Metal over Metal.....	30
Perforation and Mitered Corners	31
Coating Systems	31





Magna-Loc 90

- ▶ Architectural/structural flat pan standing seam roof panel
- ▶ 16" or 18" panel coverage, 2" rib height
- ▶ Gauges: 24 ga. standard, 22 ga. optional
- ▶ Minimum roof slope: 1/2:12
- ▶ Factory-applied side lap sealant
- ▶ Mechanically seamed side lap
- ▶ Concealed clip designed for thermal movement
- ▶ Accommodates 1/2" to 6" blanket insulation
- ▶ Applies over open framing or solid substrate
- ▶ Finishes: PVDF and Acrylic Coated Galvalume®
- ▶ Contact Metal Sales for load-carrying capabilities

Testing and Approvals

- ▶ UL 263, Fire Resistance Rating – per assembly
- ▶ UL 580, Class 90 Wind Uplift, Construction #506, 506A and 506B
- ▶ UL 790, Class A Fire Resistance Rating – per assembly
- ▶ UL 2218, Class 4 Impact Resistance
- ▶ ASTM E 1592 Roof Uplift
- ▶ ASTM E 1646 Water Penetration - none at 12 psf*
- ▶ ASTM E 1680 Air Leakage - 0.016 cfm/ft² at 12 psf*
- ▶ ASTM E 2140 Water Penetration, Static Head - none*
- ▶ Texas Department of Insurance Evaluation Report, RC-197
- ▶ Factory Mutual Approved, 1-90, 1-105, 1-165
- ▶ Miami-Dade County Approved, NOA 23-1011.10 and 23-1011.11
- ▶ ICC Evaluation Report, ESR-2385
- ▶ 2023 FBC Approved
 - Magna-Loc 90 24 ga. over 16 ga. Purlins, FL10999.5 (16" Panel)
 - Magna-Loc 90 24 ga. over 5/8" Plywood, FL11560.5 (16" Panel)
 - Magna-Loc 90 24 ga. over 22 ga. Metal Deck, FL11560.6 (16" Panel)
 - Magna-Loc 90 0.032" Alum over 22 ga. Metal Deck, FL10999.2 (16" Panel)

*with tube sealant at clip locations

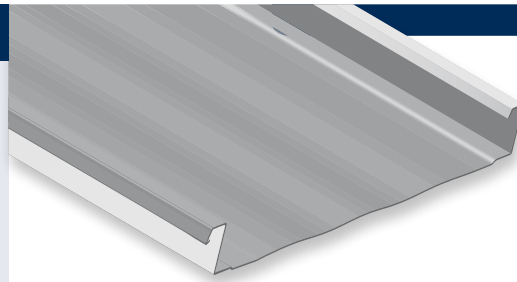

Striated

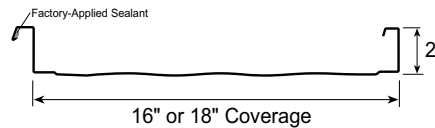

Pencil Ribs

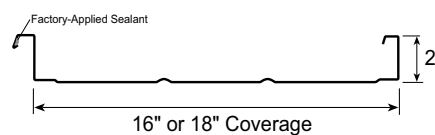

Flat

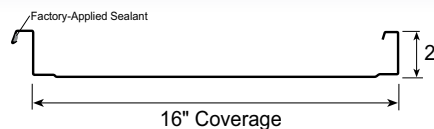

Magna-Loc 180

- ▶ Architectural/structural flat pan standing seam roof panel
- ▶ 16" or 18" panel coverage, 2" rib height
- ▶ Gauges: 24 ga. standard, 22 ga. optional
- ▶ Minimum roof slope: 1/2:12
- ▶ Factory-applied side lap sealant
- ▶ Mechanically seamed side lap
- ▶ Concealed clip designed for thermal movement
- ▶ Accommodates 1/2" to 6" blanket insulation
- ▶ Applies over open framing or solid substrate
- ▶ Finishes: PVDF and Acrylic Coated Galvalume®
- ▶ Contact Metal Sales for load-carrying capabilities

Testing and Approvals

- ▶ UL 263, Fire Resistance Rating – per assembly
- ▶ UL 580, Class 90 Wind Uplift, Construction #576, 577 and 583
- ▶ UL 790, Class A Fire Resistance Rating – per assembly
- ▶ UL 2218, Class 4 Impact Resistance
- ▶ ASTM E 1592 Roof Uplift
- ▶ ASTM E 1646 Water Penetration
- ▶ ASTM E 1680 Air Leakage
- ▶ 2023 FBC Approved
 - Magna-Loc 180 24 ga. over 16 ga. Purlins, FL10999.6 (16" Panel)

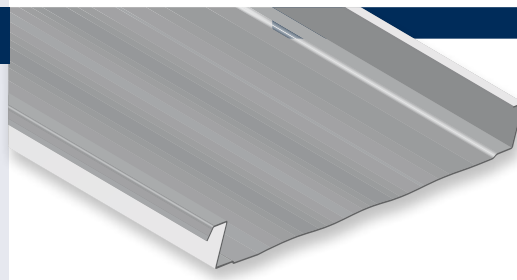

Striated

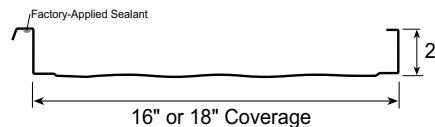

Pencil Ribs

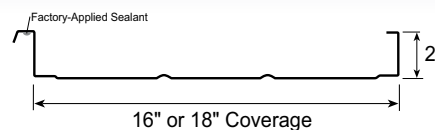

Flat

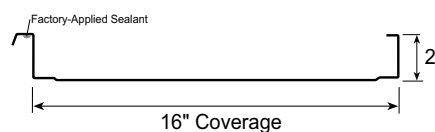

T-Armor Series™

- ▶ Structural "T" standing seam roof panel
- ▶ 12", 16" or 18" panel coverage
- ▶ Rib Height: 2-3/8" or 3"
- ▶ Finishes: PVDF and Acrylic Coated Galvalume®
- ▶ Gauges: 24 ga. standard, 22 ga. optional
- ▶ Aluminum: 0.032"
- ▶ Minimum roof slope: 1/2:12
- ▶ Integral mechanically seamed side lap
- ▶ "T" style rib allows for easy single panel replacement
- ▶ Factory-applied side lap sealant
- ▶ Concealed clip designed for thermal movement
- ▶ Accommodates 1/2" to 6" blanket insulation
- ▶ Applies over open framing or solid substrate
- ▶ Contact Metal Sales for load-carrying capabilities



Testing and Approvals

- ▷ UL 263, Fire Resistance Rating – per assembly
- ▷ UL 580, Class 90 Uplift, Construction #268, 268A and 268B
- ▷ UL 790, Class A Fire Resistance Rating – per assembly
- ▷ UL 1897, Uplift Load
- ▷ UL 2218, Class 4 Impact Resistance
- ▷ ASTM E 283 Air Infiltration
- ▷ ASTM E 330 Uniform Static Air Pressure Difference
- ▷ ASTM E 331 Water Penetration
- ▷ ASTM E 1592 Roof Uplift
- ▷ ASTM E 1646 Water Penetration
- ▷ ASTM E 1680 Air Leakage
- ▷ ASTM E 1886, 1996 Impact
- ▷ ASTM E 2140 Water Penetration, Static Head - none*
- ▷ TAS 201, 203 Impact
- ▷ TAS 100, Wind Driven Rain
- ▷ ICC 500 / FEMA 361
- ▷ AAMA 501.1, Dynamic Water
- ▷ FM 4470, Foot Traffic

*with tube sealant at clip locations

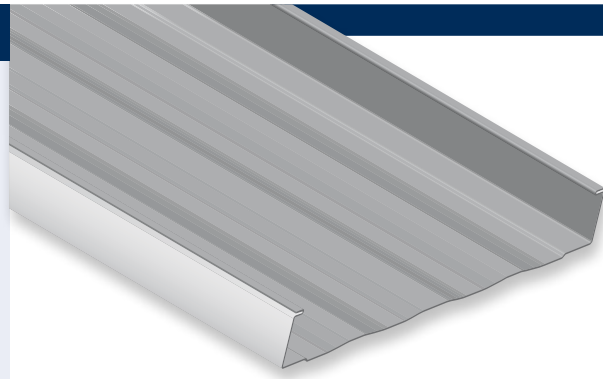

Flat

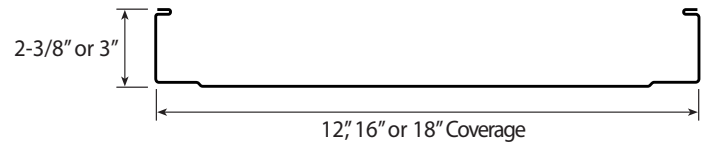

Striated

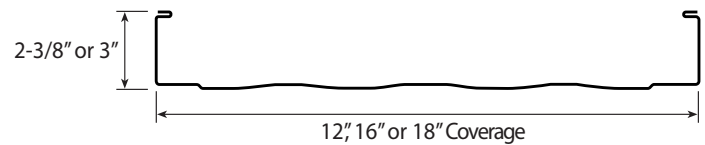

Pencil Rib

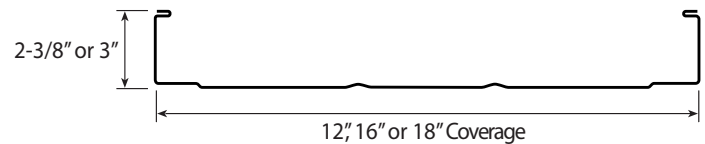

Minor Rib

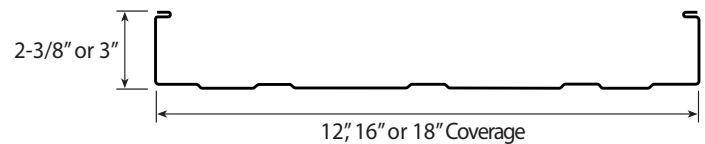

Plank

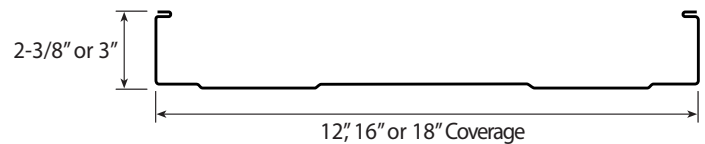

Mesa

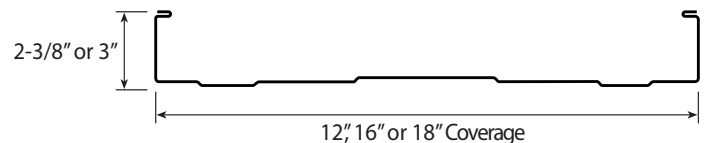

Seam-Loc 24®

- ▶ Structural trapezoidal standing seam roof panel
- ▶ 24" panel coverage, 2-11/16" rib height
- ▶ Gauges: 24 ga. standard, 22 ga. optional
- ▶ Minimum roof slope: 1/4:12
- ▶ Factory-applied side lap sealant
- ▶ Pittsburgh double flat locking mechanically seamed side lap
- ▶ Concealed clip designed for thermal movement
- ▶ Accommodates 1/2" to 6" blanket insulation
- ▶ Applies over open framing or solid substrate
- ▶ Finishes: PVDF and Acrylic Coated Galvalume®
- ▶ Contact Metal Sales for load-carrying capabilities

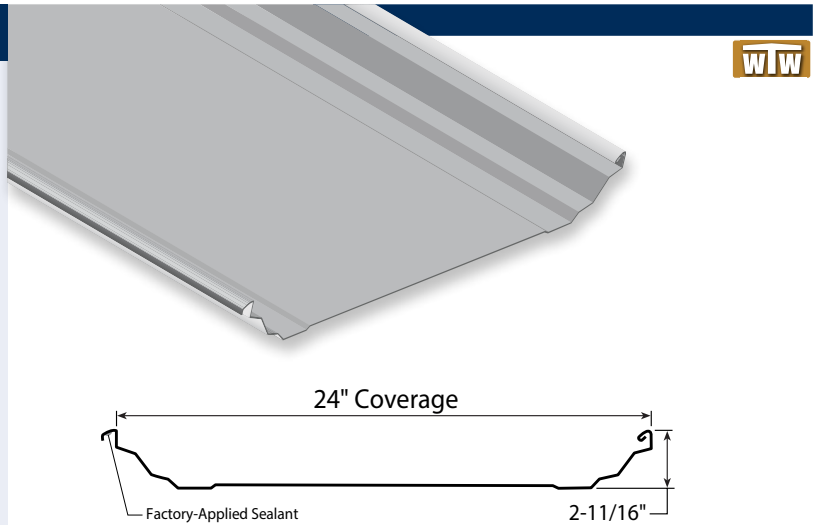

WTW

Testing and Approvals

- ▷ UL 263, Fire Resistance Rating – per assembly
- ▷ UL 580, Class 90 Wind Uplift, Construction, #197 and 197A
- ▷ UL 790, Class A Fire Resistance Rating – per assembly
- ▷ UL 2218, Class 4 Impact Resistance
- ▷ ASTM E 1592 Roof Uplift
- ▷ ASTM E 1646 Water Penetration
- ▷ ASTM E 1680 Air Leakage
- ▷ 2023 FBC Approved
 - 24" wide over 16 ga. Purlins, FL10999.8
 - 24" wide (with clamps) over 16 ga. Purlins, FL10999.9



Snap-Loc 24®

- ▶ Structural trapezoidal standing seam roof panel
- ▶ 24" panel coverage, 3" rib height
- ▶ Gauges: 24 ga. standard, 22 ga. optional
- ▶ Minimum roof slope: 1/4:12
- ▶ Factory-applied side lap sealant
- ▶ Snap-together panel system
- ▶ Concealed clip designed for thermal movement
- ▶ Accommodates 1/2" to 6" blanket insulation
- ▶ Applies over open framing or solid substrate
- ▶ Finishes: PVDF and Acrylic Coated Galvalume®
- ▶ Contact Metal Sales for load-carrying capabilities

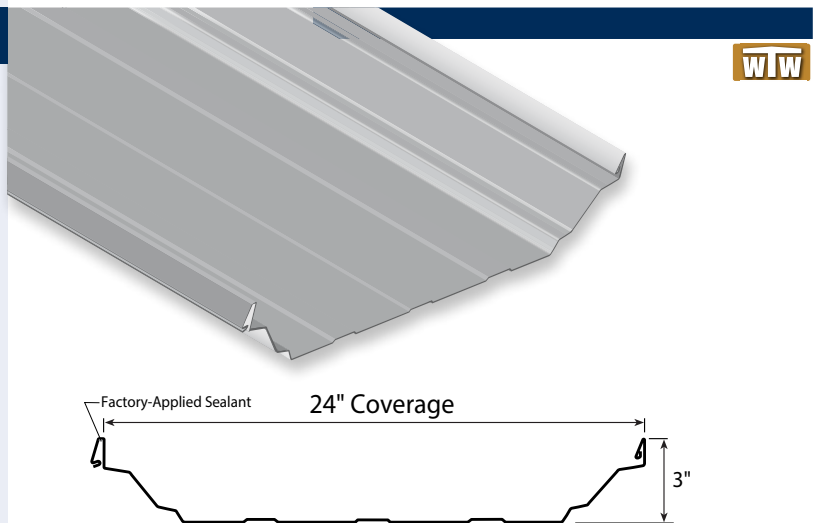

WTW

Testing and Approvals

- ▷ UL 263, Fire Resistance Rating – per assembly
- ▷ UL 580, Class 90 Uplift, Construction, #240
- ▷ UL 790, Class A Fire Resistance Rating – per assembly
- ▷ UL 2218, Class 4 Impact Resistance
- ▷ ASTM E 330, Uniform Static Air Pressure Difference
- ▷ ASTM E 1592 Roof Uplift
- ▷ ASTM E 1646 Water Penetration
- ▷ ASTM E 1680 Air Leakage



Vertical Seam

- ▶ Architectural/structural standing seam panel
- ▶ Panel Coverage: 12", 16" or 18"
- ▶ Rib Height: 1-3/4"
- ▶ Gauges: 26 ga. and 24 ga. standard, 22 ga. optional
- ▶ Snap-together panel system with factory-applied side lap sealant
- ▶ Minimum roof slope over open framing 3:12
- ▶ Minimum roof slope over solid substrate 1:12
- ▶ Concealed clip designed for unlimited thermal movement
- ▶ Accommodates up to 4" blanket insulation
- ▶ Finishes: PVDF, MS Colorfast45® and Acrylic Coated Galvalume®
- ▶ Contact Metal Sales for load-carrying capabilities

Vertical Seam Plus

- ▶ Square Batten Cap option for Vertical Seam Panel
- ▶ Available at the Fontana Branch only

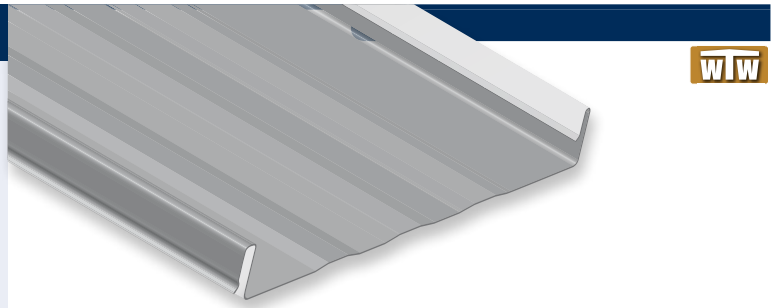
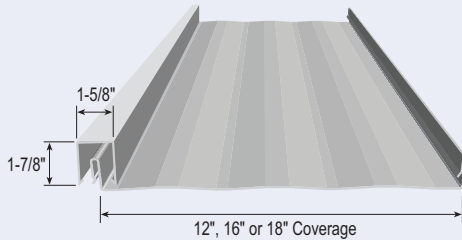

Striated

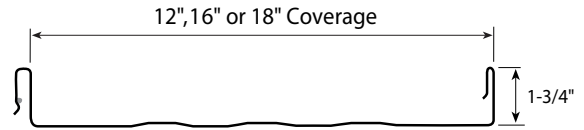

Flat Pan

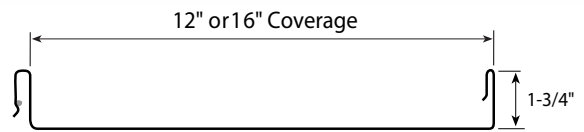

Testing and Approvals

- ▶ UL 263, Fire Resistance Rating – per assembly
- ▶ UL 580, Class 90 Wind Uplift, Construction, #254, 255, 261, 303, 342, 343, 436, 445, 446, 447, 448, 508 and 508A
- ▶ UL 790, Class A Fire Resistance Rating – per assembly
- ▶ UL 2218, Class 4 Impact Resistance
- ▶ ASTM E 1592 Roof Uplift
- ▶ ASTM E 1646 Water Penetration
- ▶ ASTM E 1680 Air Leakage
- ▶ Miami-Dade County Approved, NOA 18-1227.01
- ▶ Texas Department of Insurance Evaluation Report, RC-412
- ▶ ICC Evaluation Report, ESR-2385
- ▶ 2023 FBC Approved
 - 26 ga. over 1/2" Plywood, FL11560.9 (16" Panel)
 - 24 ga. over 1/2" Plywood, FL11560.7 (16" Panel)
 - 24 ga. over 1/2" Plywood, FL11560.8 (18" Panel)
 - 0.032" Aluminum over 7/16" OSB, FL14645.4 (16" Panel)
 - 0.032" Aluminum over 5/8" Plywood, FL14645.5 (16" Panel)



Clip-Loc

- ▶ Architectural/structural integral standing rib roof system
- ▶ Snap-together panel system
- ▶ 16" panel coverage, major rib: 8" centers, 1-5/8" rib height
- ▶ Gauges: 26 ga., 24 ga. standard and 22 ga. optional
- ▶ Minimum roof slope: 1:12
- ▶ Applies over open framing or solid substrate
- ▶ Concealed clip designed for thermal movement
- ▶ Accommodates up to 4" blanket insulation
- ▶ Finishes: PVDF and Acrylic Coated Galvalume®
- ▶ Contact Metal Sales for load-carrying capabilities

Testing and Approvals

- ▶ UL 263, Fire Resistance Rating – per assembly
- ▶ UL 580, Class 90 Wind Uplift, Construction, #586 and 586A
- ▶ UL 790, Class A Fire Resistance Rating – per assembly
- ▶ UL 1897, Uplift Tests for Roof Covering Systems
- ▶ UL 2218, Class 4 Impact Resistance
- ▶ ASTM E 1592 Roof Uplift
- ▶ ASTM E 1680 Air Leakage
- ▶ ICC Evaluation Report, ESR-2385

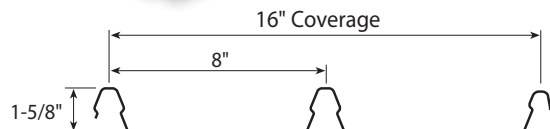
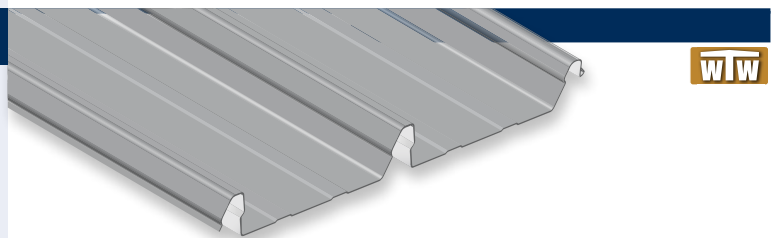
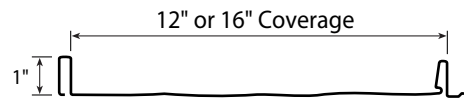
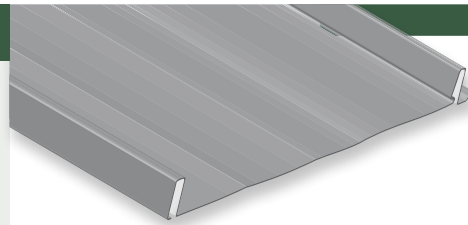

Image II

- ▶ Architectural concealed direct-fastened roof panel
- ▶ Panel coverage: 12" or 16"
- ▶ 1" rib height
- ▶ Gauges: 26 ga. standard
- ▶ Minimum roof slope: 3:12
- ▶ Applies over solid substrate with 30# felt underlayment
- ▶ Finishes: MS Colorfast45®, PVDF and Acrylic Coated Galvalume®
- ▶ Contact Metal Sales for load-carrying capabilities



Striated

Fastening legs vary by branch

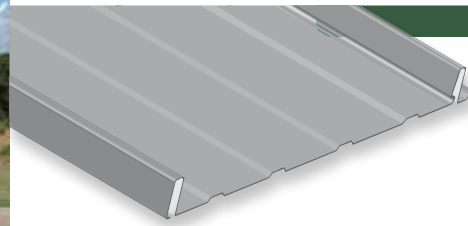
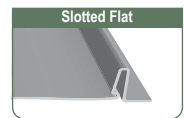

16" Minor Rib

Fastening legs vary by branch

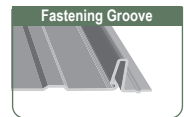
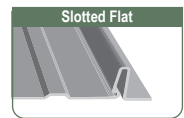

Testing and Approvals

- ▶ UL 263, Fire Resistance Rating – per assembly
- ▶ UL 580, Class 90 Wind Uplift, Construction, #529
- ▶ UL 790, Class A Fire Resistance Rating – per assembly
- ▶ UL 2218, Class 4 Impact Resistance
- ▶ Miami-Dade County approved, NOA 23-0711.05
- ▶ Texas Department of Insurance Evaluation Reports, RC-162, RC-398 and RC-399
- ▶ ICC Evaluation Report, ESR-2385
- ▶ 2023 FBC Approved
 - 26 ga. over 1/2" Plywood, FL11560.4
 - 26 ga. over 7/16" OSB, FL14645.10
 - 0.032" Aluminum over 7/16" OSB, FL11560.2
 - 0.032" Aluminum over 1/2" Plywood, FL11560.3

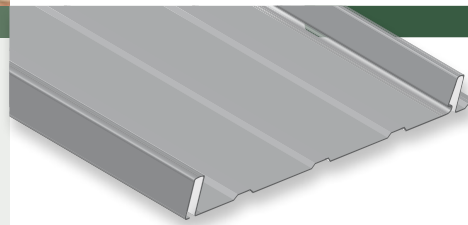

12" Minor Rib

Fastening legs vary by branch

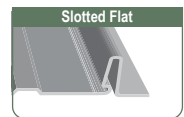

Mini-Batten

- ▶ Architectural standing seam roof panel
- ▶ 12", 16" or 18" panel coverage, minimum roof slope: 3:12
- ▶ Mini-Batten offers, 1" & 1-1/2" high rib utilizing a narrow batten cap
- ▶ Gauges: 26 ga. and 24 ga. standard, 22 ga. optional
- ▶ Concealed clip designed for thermal movement
- ▶ Applies over solid substrate with 30# felt underlayment
- ▶ Finishes: PVDF, MS Colorfast45[®] and Acrylic Coated Galvalume[®]
- ▶ Contact Metal Sales for load-carrying capabilities

1" Mini-Batten

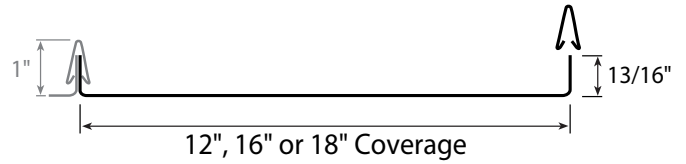
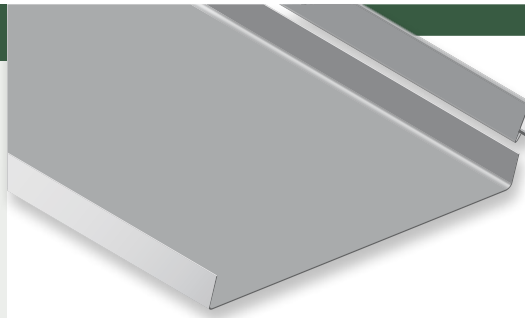

Testing and Approvals

- ▷ UL 263, Fire Resistance Rating – per assembly
- ▷ UL 580, Class 90 Wind Uplift, Construction, #397, 397A and 430 (1" Mini-Batten)
- ▷ UL 580, Class 90 Wind Uplift, Construction, #352 (1-1/2" Mini-Batten)
- ▷ UL 790, Class A Fire Resistance Rating – per assembly
- ▷ UL 2218, Class 4 Impact Resistance
- ▷ ASTM E 283 Air Leakage
- ▷ ASTM E 331 Water Penetration

Curved Mini-Batten

- ▶ Minimum radius 4'-0"

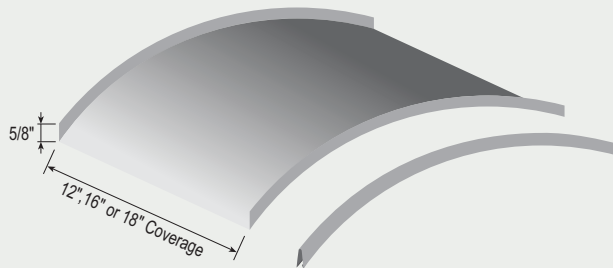

1.5" Mini-Batten

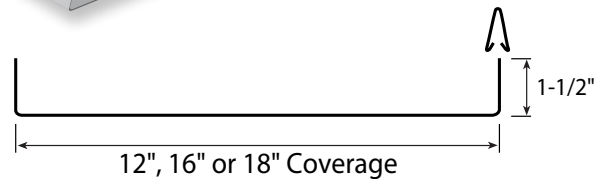
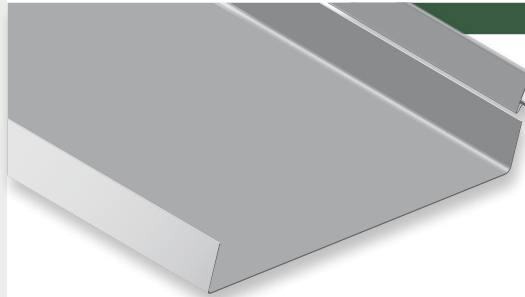

Maxi-Batten

- ▶ Architectural standing seam roof panel
- ▶ 12", 16" or 18" panel coverage, minimum roof slope: 3:12
- ▶ Maxi-Batten Cap, 1-5/8" x 1-7/8"
- ▶ Gauges: 26 ga. and 24 ga. standard, 22 ga. optional
- ▶ Concealed clip designed for thermal movement
- ▶ Applies over solid substrate with 30# felt underlayment
- ▶ Finishes: PVDF, MS Colorfast45[®] and Acrylic Coated Galvalume[®]
- ▶ Contact Metal Sales for load-carrying capabilities

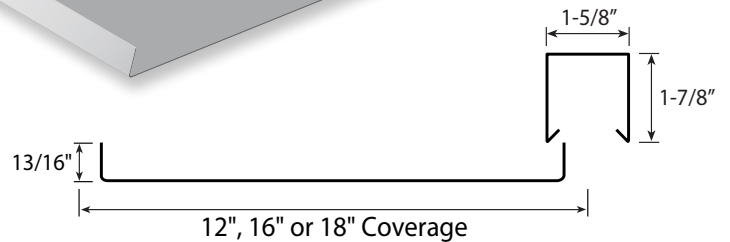
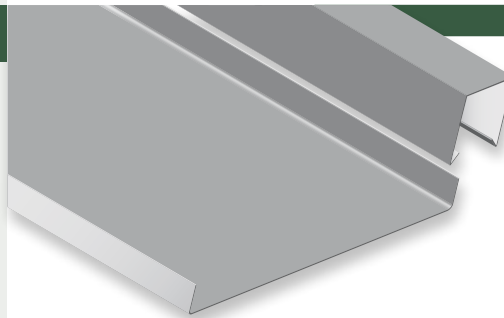

Testing and Approvals

- ▷ UL 263, Fire Resistance Rating – per assembly
- ▷ UL 580, Class 90 Wind Uplift, Construction, #398 and 398A
- ▷ UL 790, Class A Fire Resistance Rating – per assembly
- ▷ UL 2218, Class 4 Impact Resistance
- ▷ ASTM E 283 Air Leakage
- ▷ ASTM E 331 Water Penetration



Board and Batten

- ▶ Concealed direct-fastened panel for wall or liner applications
- ▶ 10", 12" panel coverage
- ▶ 3/4" rib height
- ▶ 30'-0" maximum length
- ▶ Vertical or Horizontal application
- ▶ Gauge: 24 ga. steel standard
- ▶ Aluminum Substrate: 0.032" optional
- ▶ Applies over open framing or solid substrate
- ▶ Finishes: PVDF and Acrylic Coated Galvalume®
- ▶ Contact Metal Sales for load-carrying capabilities

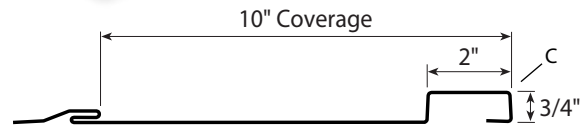
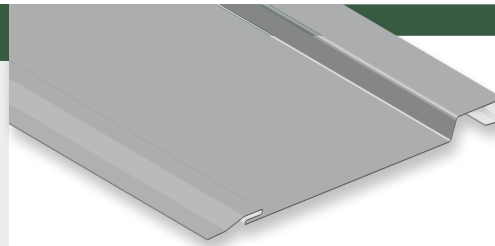

Testing and Approvals

- ▶ ASTM E 283 Air Infiltration
- ▶ ASTM E 330 Uniform Static Air Pressure Difference
- ▶ ASTM E 331 Water Penetration

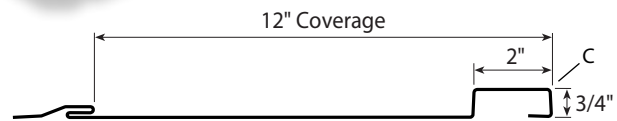
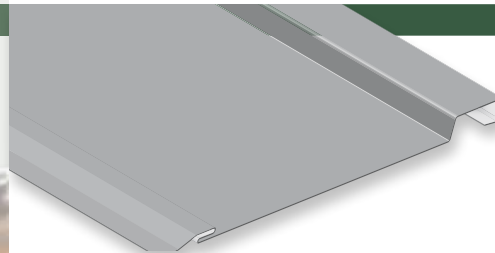

TLC Series

- ▶ Concealed direct-fastened panel for wall, soffit, fascia or liner applications
- ▶ 12" panel coverage
- ▶ 1-1/2" panel depth
- ▶ 40'-0" maximum length, roll-formed panel
- ▶ Gauges: 24 ga. standard, 22 ga. and 20 ga. optional
- ▶ Optional Alum: 0.032" or 0.040" Aluminum
- ▶ Applies over open framing or solid substrate
- ▶ Finishes: PVDF and Acrylic Coated Galvalume®
- ▶ Optional material: stainless steel, aluminum and copper
- ▶ Custom capabilities include:
 - Perforated panels for wind screens and liner panels
- ▶ Contact Metal Sales for load-carrying capabilities

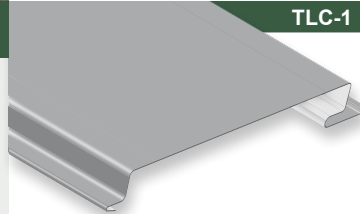

TLC-1

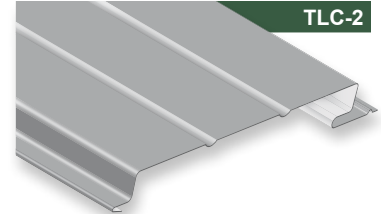

TLC-2

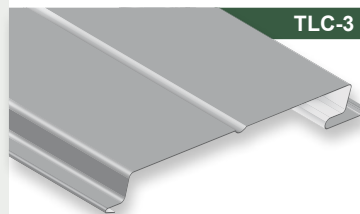
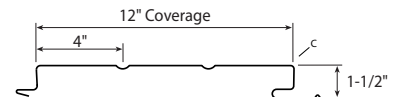

TLC-3

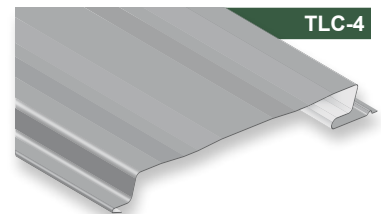

TLC-4

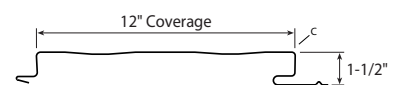
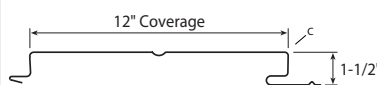

Testing and Approvals

- ▶ UL 263, Fire Resistance Rating – per assembly
- ▶ ASTM E 283 Air Infiltration
- ▶ ASTM E 330 Uniform Static Air Pressure Difference
- ▶ ASTM E 331 Water Penetration
- ▶ ASTM E 1592 Roof Uplift

TLC Series

Concealed-Fastened Flush Panel

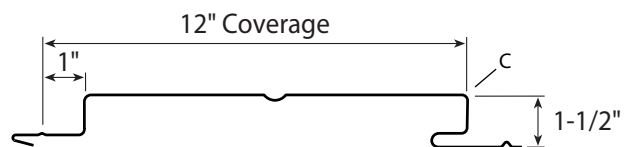
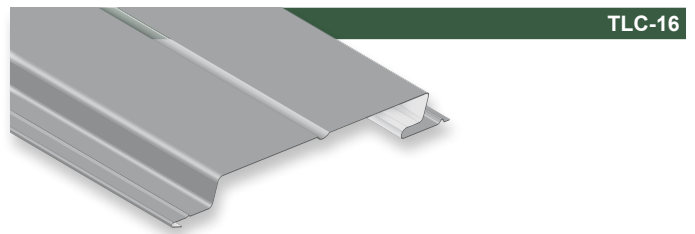
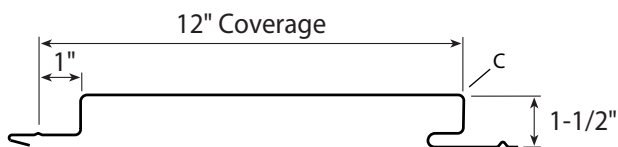
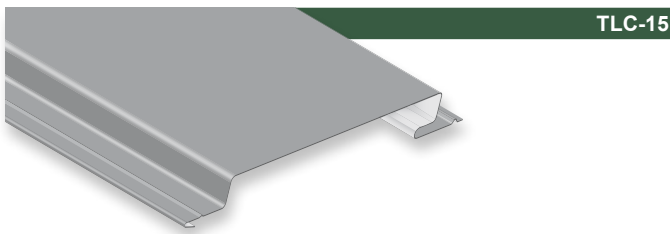
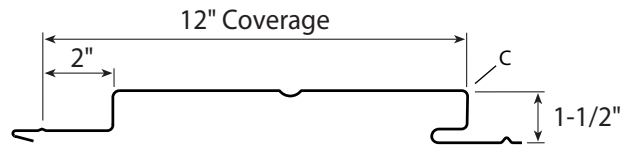
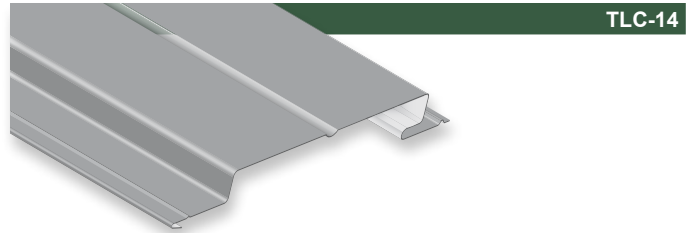
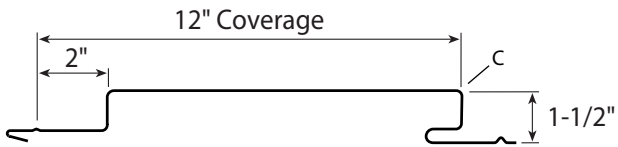
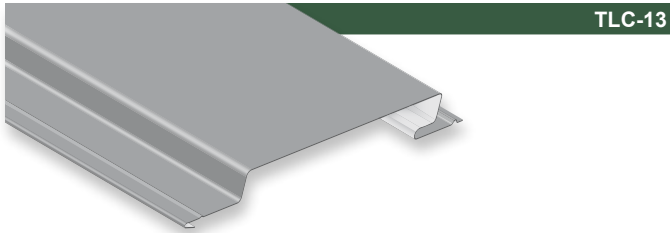
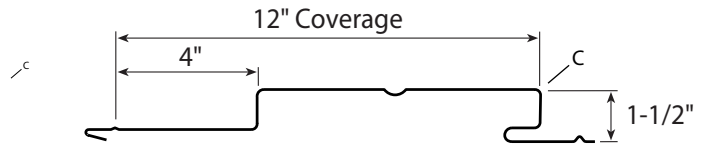
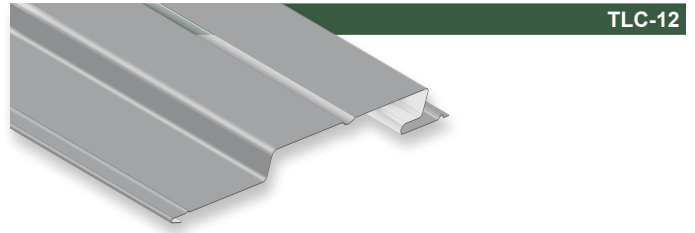
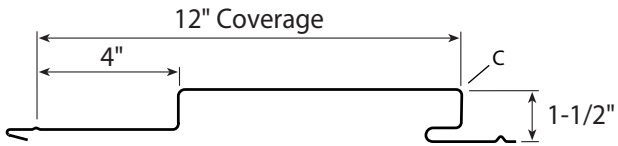
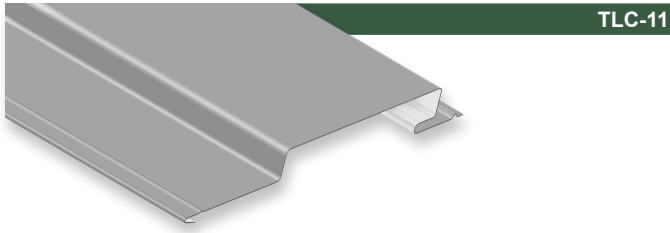
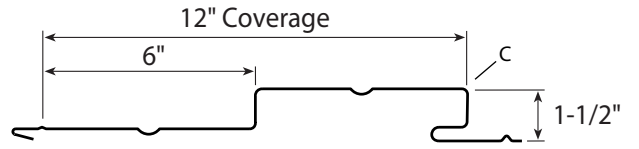
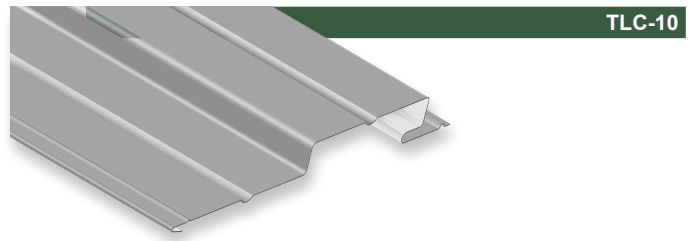
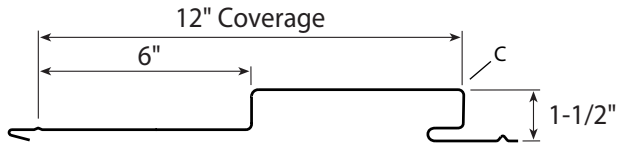
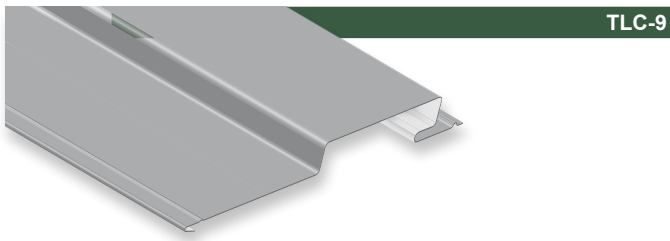

Concealed Fastened Wall Panels

- ▶ Concealed direct-fastened panel for wall applications
- ▶ Panel lengths available from 5'-0" to 30'-0" max*
- ▶ Gauges: 24 ga. standard; 22 ga. optional
- ▶ Applies over open framing or solid substrate
- ▶ Finishes: PVDF and Acrylic Coated Galvalume®
- ▶ Horizontal and Vertical installation
- ▶ Common joinery allows panel profile to be mixed and matched for increased design flexibility
- ▶ High-strength clip allows for thermal and seismic movement

*Standard max length of 20' for AP1-1212, CN88-1212 and EM1-1212.

Testing and Approvals

- ▶ ASTM E 283 Air Infiltration
- ▶ ASTM E 330 Load Testing
- ▶ ASTM E 331 Water Penetration
- ▶ ASTM E 1592 Roof Uplift
- ▶ 2023 FBC Approved
 - 24 ga. Apex Series, FL34027.1
 - 24 ga. Contempra Series, FL34027.2
 - 24 ga. EM1 Series, FL34027.3
 - 24 ga. EM15 Series, FL34027.4
 - 24 ga. EM15-1222 Series, FL34027.5



Apex Series™ Symmetrical Rib

AP1-1212

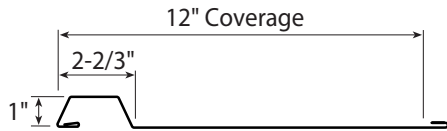

AP1-124

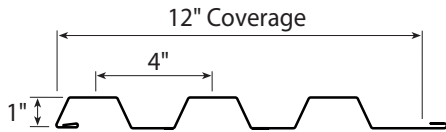

AP1-168

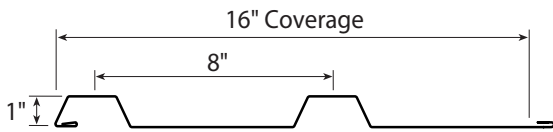

AP1-1653

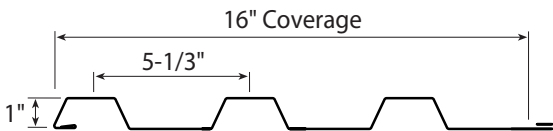

AP1-164

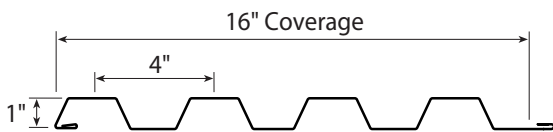

Contempra Series™ Asymmetrical Rib

CN88-1212

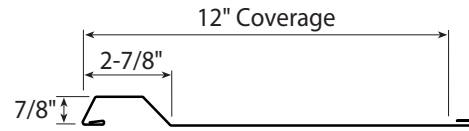

CN88-124

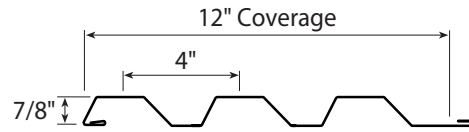

CN88-168

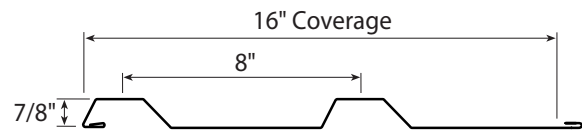

CN88-1653

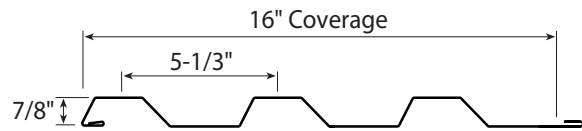

CN88-164

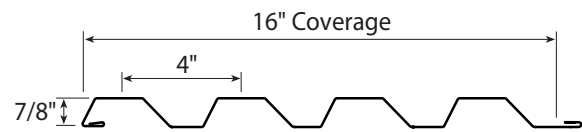

EM1 Series ■ EMPIRE LINE

Box Rib

EM1-1212

EM1-124

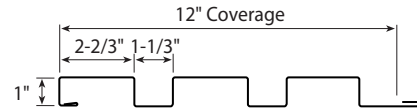
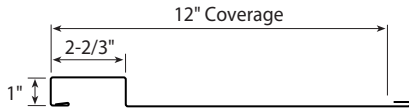

EM1-168

EM1-1653

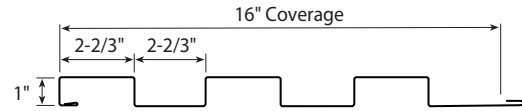
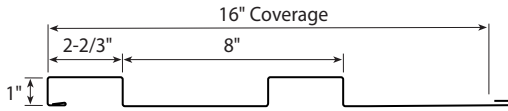

EM15 Series ■ EMPIRE LINE

Box Rib

EM15-126

EM15-168

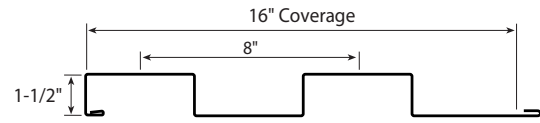
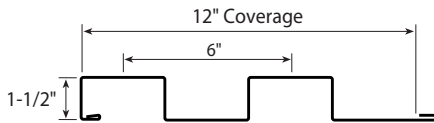

EM15-1266

EM15-1275

EM15-1284

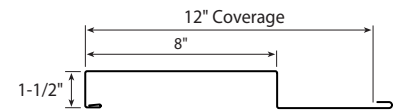
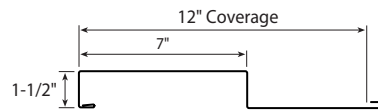
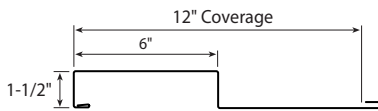

EM15-1293

EM15-1210

EM15-1211

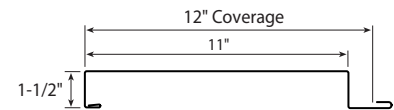
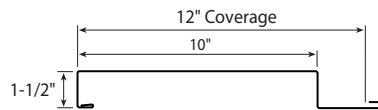
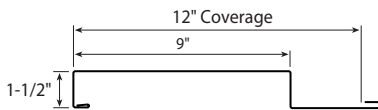

EM15-1222 Series ■ EMPIRE LINE

Box Rib

EM15-1222

EM15-1226

EM15-262

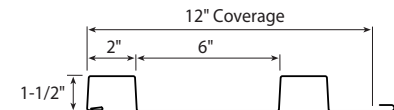
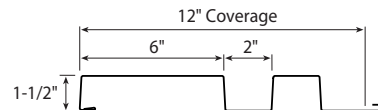
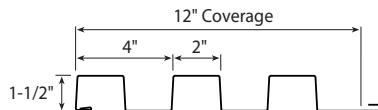

EM15-1224

EM15-1262

EM15-622

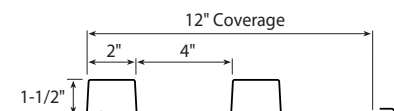
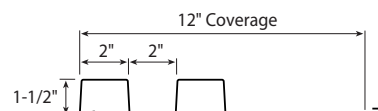
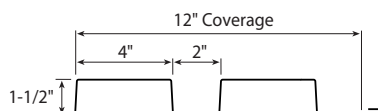

Soffit Panel

- ▶ Concealed direct-fastened system for soffit, wall, fascia or liner applications
- ▶ 12" panel coverage
- ▶ 1" depth
- ▶ Max Panel Length: 26 ga. 5'-0", 24 ga. 20'-0" and 0.032" Alum 25'-0"
- ▶ Gauges: 26 ga., 24 ga. std. 22 ga. and 0.032" aluminum optional
- ▶ Optional Aluminum: 0.032"
- ▶ Lanced and Perforated versions are available
- ▶ Applies over solid substrate with 30# felt underlayment
- ▶ Finishes: MS Colorfast45®, PVDF and Acrylic Coated Galvalume®
- ▶ Contact Metal Sales for load-carrying capabilities

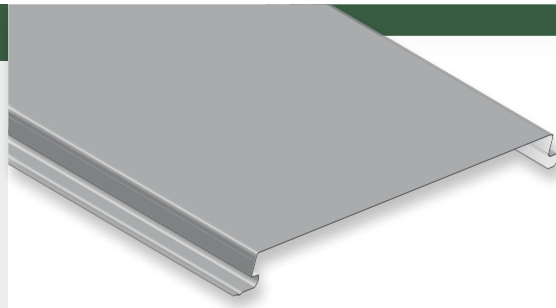

Testing and Approvals

- ▷ UL 263, Fire Resistance Rating – per assembly
- ▷ ASTM E 283 Air Infiltration
- ▷ ASTM E 330 Uniform Static Air Pressure Difference
- ▷ ASTM E 331 Water Penetration
- ▷ 2023 FBC Approved
- 24 ga. panel over 16 ga. Girts, 9482.5



Lanced Soffit V-Grooves

Perforated V-Grooves

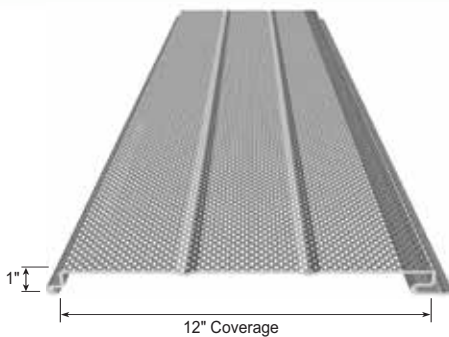

Flat

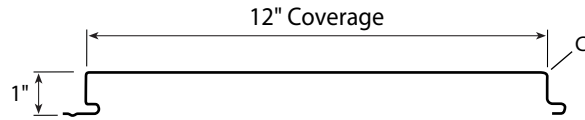

V-Grooves

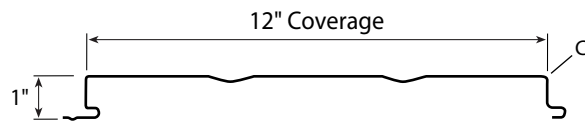

Lanced Flat

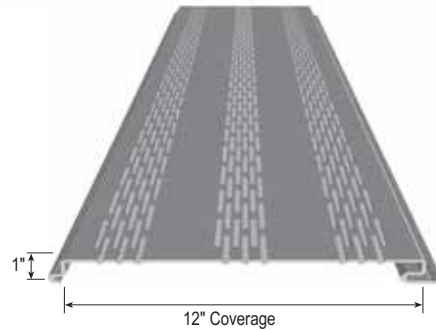

Lanced V-Grooves

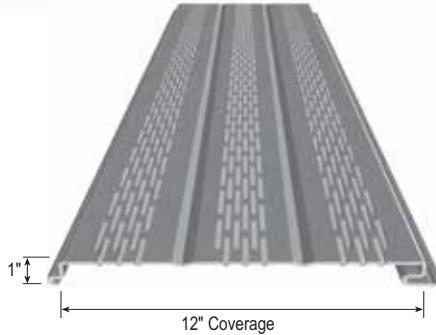

Perforated Flat

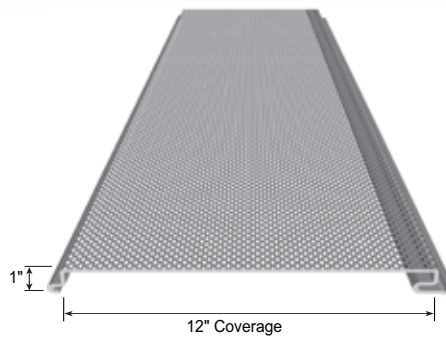

T10 Series

- ▶ Exposed direct-fastened panel for wall, soffit, fascia and liner panel
- ▶ Applies over open framing or solid substrate
- ▶ 28", 30" and 36" panel coverages, 1-1/2" rib height
- ▶ 90° vertical box ribs on 4", 6" and 9" centers
- ▶ Gauges: 24 ga. standard, 22 ga., 20 ga. and 18 ga. optional
- ▶ Optional Aluminum: 0.032", 0.040" or 0.050"
- ▶ Optional material: stainless steel, aluminum and copper
- ▶ Custom capabilities include:
 - Perforated panels for wind screens and liner panels
- ▶ Standard Finish: PVDF and Acrylic Coated Galvalume®
- ▶ Contact Metal Sales for load-carrying capabilities



T10-C Wall

Testing and Approvals

- ▷ UL 263, Fire Resistance Rating — per assembly
- ▷ UL 2218, Class 4 Impact Rating
- ▷ ICC Evaluation Report, ESR 4633

T10-A Wall Panel

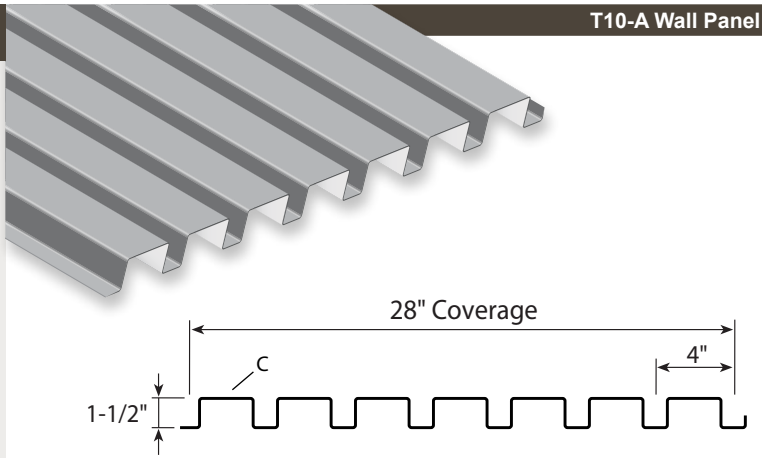

T10-B Wall Panel

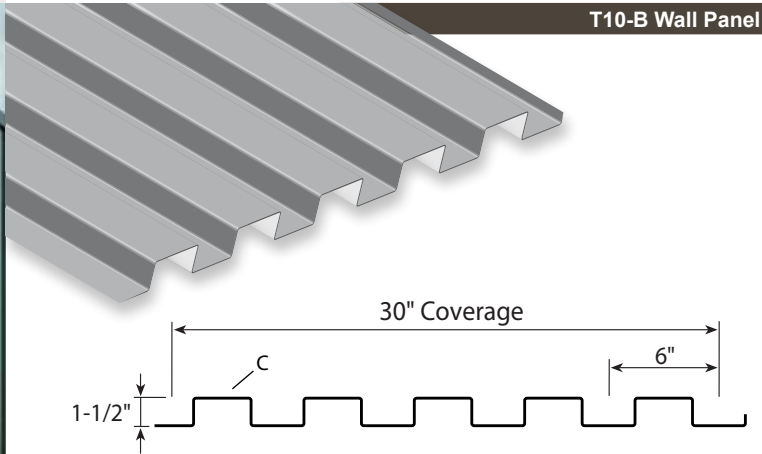

T10-C Wall Panel

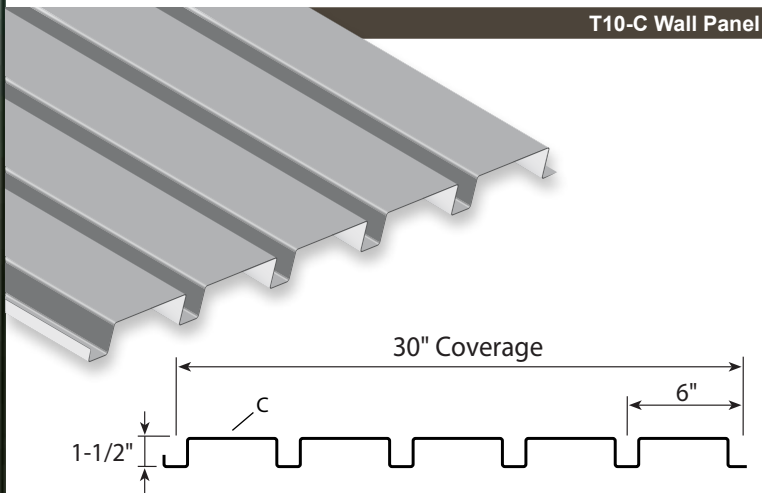

T10-D Wall Panel

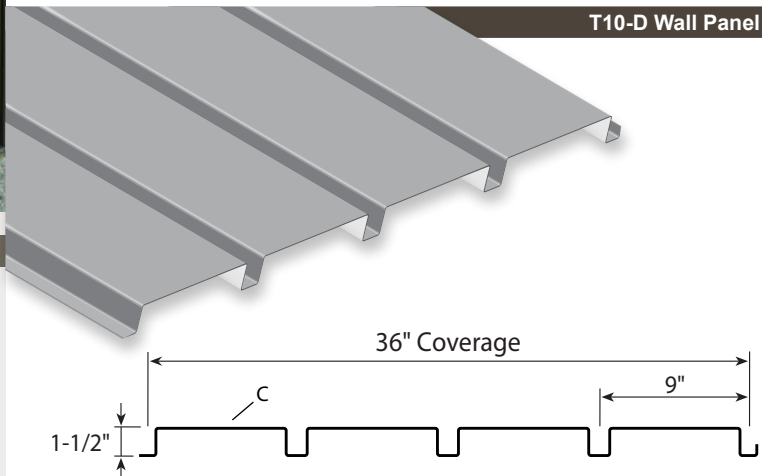

7/8" Corrugated

- ▶ Exposed direct-fastened panel for roof and wall applications
- ▶ 32" roof coverage (34-2/3" wall coverage)
- ▶ 7/8" rib height, 2-2/3" centers
- ▶ Gauges: 26 ga. and 24 ga. standard, 22 ga. and 20 ga. optional
- ▶ Optional materials: stainless steel, aluminum and weathering steel
- ▶ Minimum roof slope: 1:12
- ▶ Applies over open framing or solid substrate
- ▶ Finishes: MS Colorfast45®, PVDF and Acrylic Coated Galvalume®
- ▶ Contact Metal Sales for load-carrying capabilities

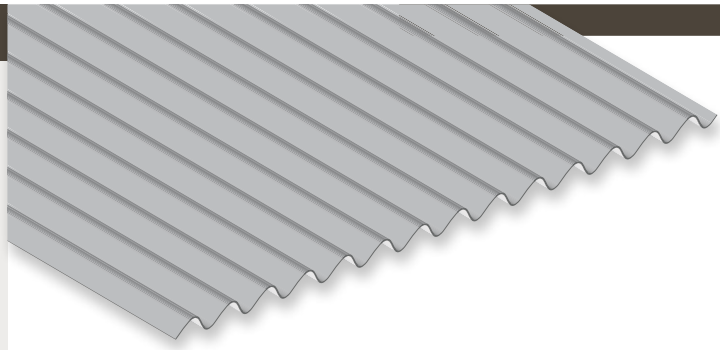

Testing and Approvals

- ▶ UL 263, Fire Resistance Rating – per assembly
- ▶ UL 790, Class A Fire Resistance Rating – per assembly
- ▶ UL 2218, Class 4 Impact Resistance
- ▶ ASTM E 283 Air Infiltration
- ▶ ASTM E 330 Uniform Static Air Pressure Difference
- ▶ ASTM E 331 Water Penetration
- ▶ ASTM E 1592 Roof Uplift Capacity
- ▶ ASTM E 1646 Water Penetration
- ▶ ASTM E 1680 Air Leakage
- ▶ Texas Department of Insurance Evaluation Report, RC-409
- ▶ ICC Evaluation Report, ESR-2385
- ▶ 2023 FBC Approved
 - 24 ga. roof panel over 16 ga. Purlins, FL10999.1
 - 24 ga. wall panel over 16 ga. Girts, FL9482.1

Roof Panel



Wall Panel

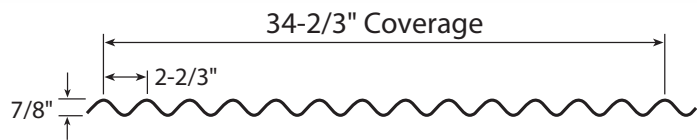

5V-Crimp

- ▶ Exposed direct-fastened roof panel, traditional "V" rib
- ▶ 24" panel coverage
- ▶ 1/2" rib height
- ▶ Gauges: 29 ga. and 26 ga. standard
- ▶ Optional Aluminum: 0.032"
- ▶ Minimum roof slope: 3:12
- ▶ Applies over solid substrate with 30# felt underlayment
- ▶ Finishes: MS Colorfast45® and Acrylic Coated Galvalume®
- ▶ Contact Metal Sales for load-carrying capabilities

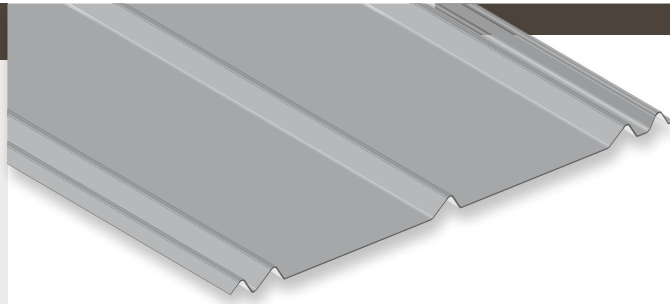

Testing and Approvals

- ▶ UL 263, Fire Resistance Rating – per assembly
- ▶ UL 580, Class 90 Wind Uplift, Construction, #453 and 579
- ▶ UL 790, Class A Fire Resistance Rating – per assembly
- ▶ UL 2218, Class 4 Impact Rating
- ▶ Miami-Dade County Approved, NOA 23-0222.06 (26 gauge)
- ▶ Miami-Dade County Approved, NOA 18-1227.02 (0.032" Aluminum)
- ▶ Texas Department of Insurance Evaluation Report, RC-160
- ▶ 2023 FBC Approved
 - 26 ga. over 5/8" Plywood, FL14645.2
 - 26 ga. over 7/16" OSB, FL14645.3
 - 0.032" Aluminum over 7/16" OSB, FL11560.1



IC72-Panel

- ▶ Exposed direct-fastened industrial panel
- ▶ Roof and wall applications
- ▶ 36" panel coverage, minimum roof slope: 1:12
- ▶ 1-1/2" rib height at 7.2" centers
- ▶ Gauges: 24 ga. standard, 22 ga. and 20 ga. optional
- ▶ Optional Aluminum: 0.032" or 0.040"
- ▶ Applies over open framing or solid substrate
- ▶ Finishes: PVDF and Acrylic Coated Galvalume®
- ▶ Contact Metal Sales for load-carrying capabilities

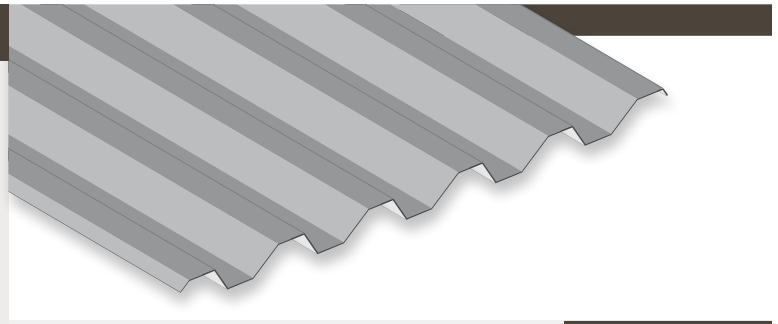

Roof Panel

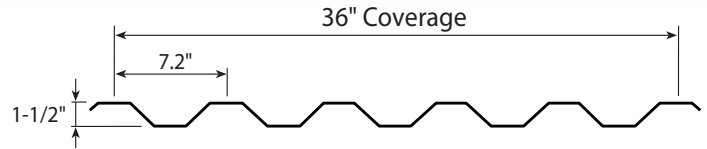

Wall Panel

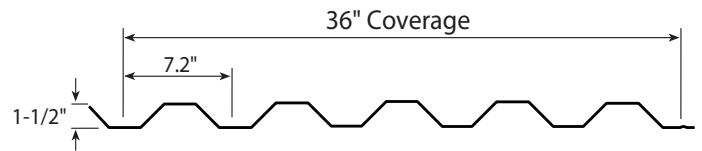

Testing and Approvals

- ▶ UL 263, Fire Resistance Rating – per assembly
- ▶ UL 790, Class A Fire Resistance Rating – per assembly
- ▶ ASTM E 283 Air Infiltration
- ▶ ASTM E 330 Uniform Static Air Pressure Difference
- ▶ ASTM E 331 Water Penetration
- ▶ ICC Evaluation Report, ESR-2385



V-Line 32

- ▶ Exposed direct-fastened panel for roof and wall applications
- ▶ 32" panel coverage
- ▶ Trapezoidal rib on 4-9/16" centers
- ▶ 1-3/8" rib height
- ▶ Gauges: 26 ga. and 24 ga. standard, 22 ga. optional
- ▶ Minimum roof slope: 1:12
- ▶ Applies over open framing or solid substrate
- ▶ Finishes: MS Colorfast45®, PVDF and Acrylic Coated Galvalume®
- ▶ Contact Metal Sales for load-carrying capabilities

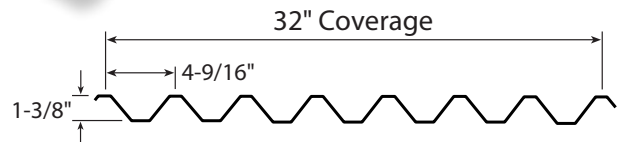
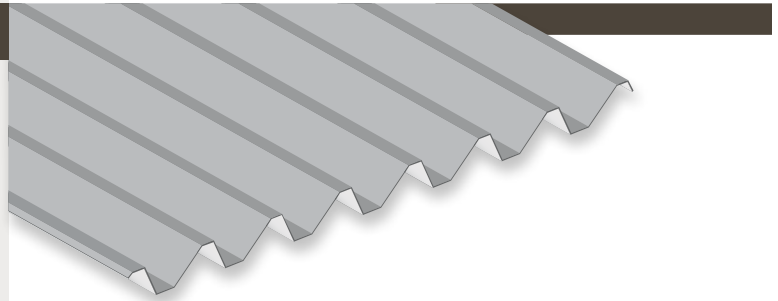

Testing and Approvals

- ▶ UL 263, Fire Resistance Rating – per assembly
- ▶ UL 580, Class 90 Wind Uplift, Construction, #187
- ▶ UL 790, Class A Fire Resistance Rating – per assembly
- ▶ UL 2218, Class 4 Impact Resistance



EXPOSED FASTENED LINE

- ▶ Exposed direct-fastened panel for roof and wall applications
- ▶ Applies over open framing or solid substrate
- ▶ Panel coverage: 32" to 44"
- ▶ Rib height: 5/8" to 1-3/4"
- ▶ Optional material: stainless steel, aluminum and copper
- ▶ Gauges: 24 ga. standard, 22 ga., 20 ga. and 18 ga. optional
- ▶ Optional Aluminum: 0.032", 0.040" or 0.050"
- ▶ Minimum roof slope: 1:12
- ▶ Standard Finish: PVDF and Acrylic Coated Galvalume®
- ▶ Contact Metal Sales for load-carrying capabilities

Other profiles are available. Please inquire.

Testing and Approvals

▶ ICC Evaluation Report, ESR-4633 – T6-A Wall, T16-E Wall, T16-L Wall



LOW RIB Series

Rib Height Under 2"

T1 Roof

T1 Wall

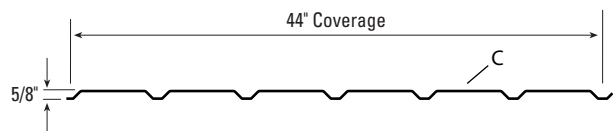
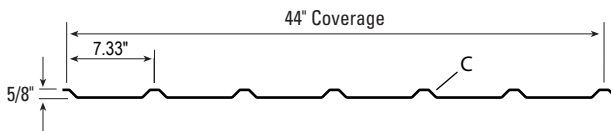

T2 Roof

T2 Wall

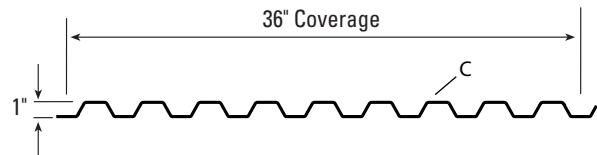
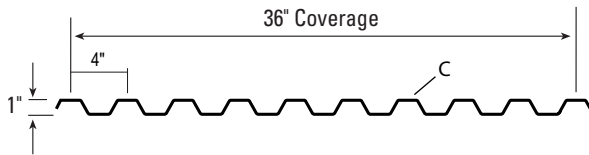

T3 Roof

T3 Wall

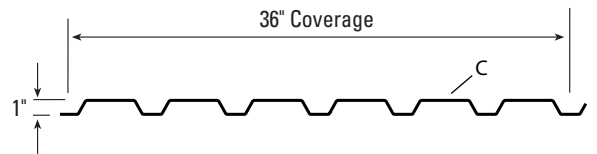
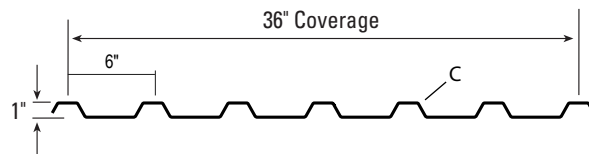

T4 Roof

T4 Wall

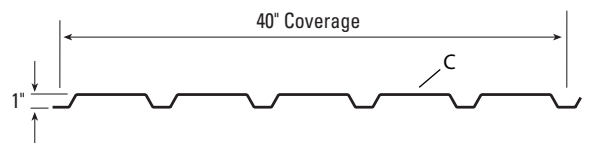
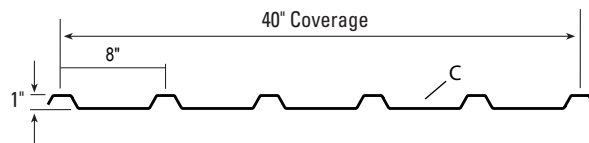

T5 Roof

T5 Wall

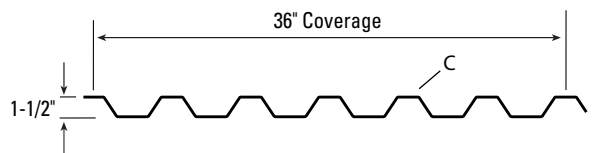
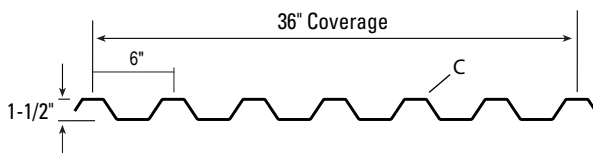

LOW RIB Series

Rib Height Under 2"

T6-A Roof

T6-A Wall

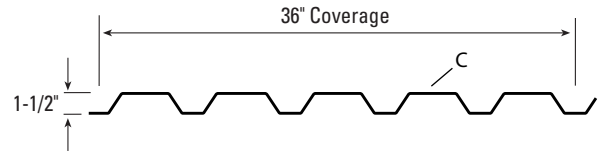
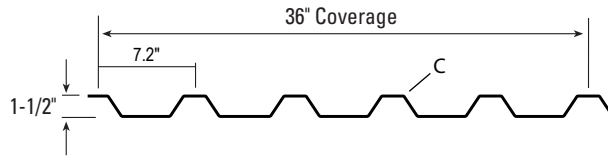

T7 Roof

T7 Wall

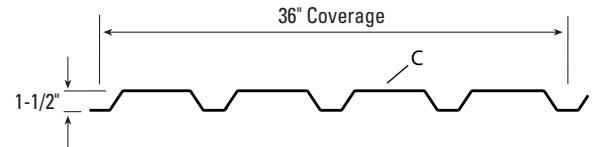
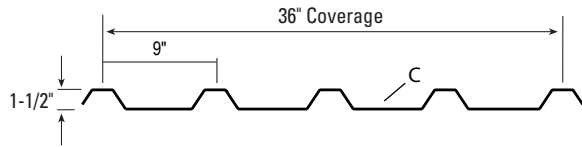

T7-A Roof

T7-A Wall

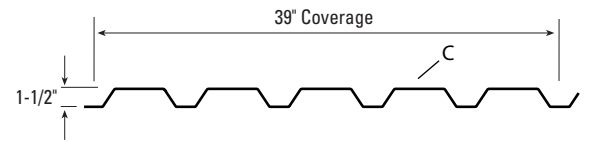
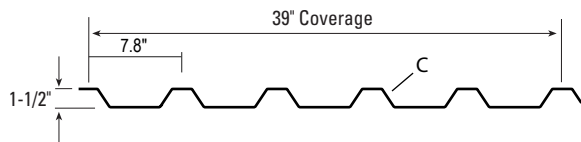

T11-A Roof

T11-A Wall

Same profile for Roof and Wall

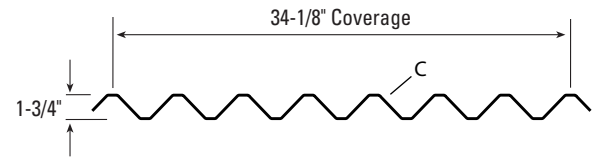
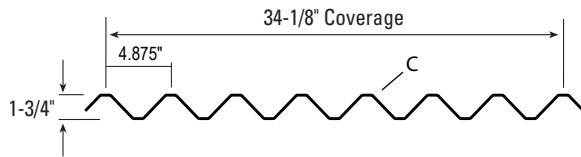

T12 Roof

T12 Wall

Same profile for Roof and Wall

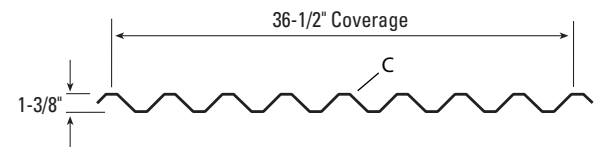
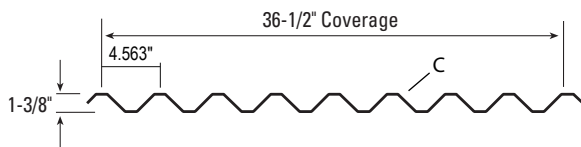

T16-E Roof

T16-E Wall

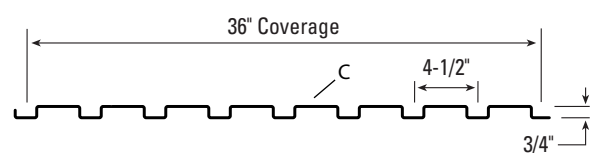
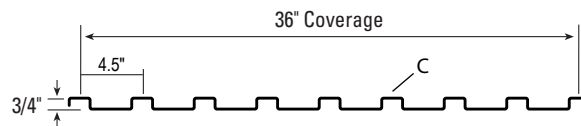

T16-L Wall

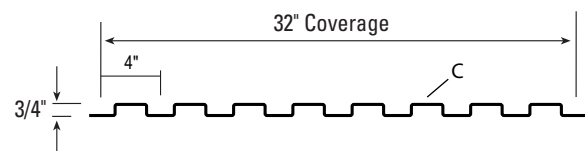

EXPOSED FASTENED LINE

- ▶ Exposed direct-fastened panel for roof and wall applications
- ▶ Applies over open framing or solid substrate
- ▶ 24", 30" or 32" panel coverages
- ▶ 2", 3" or 3-1/2" rib heights
- ▶ Optional material: stainless steel, aluminum and copper
- ▶ Gauges: 24 ga. standard, 22 ga., 20 ga. and 18 ga. optional
- ▶ Optional Aluminum: 0.032", 0.040" or 0.050"
- ▶ Minimum roof slope: 1:12
- ▶ Custom capabilities include: Perforated panels
- ▶ Standard Finish: PVDF and Acrylic Coated Galvalume®



Testing and Approvals

▶ ICC Evaluation Report, ESR-4633 – T2630 Wall

2" RIB Series

Rib Height 2"-3"

T2630 Roof

T2630 Wall

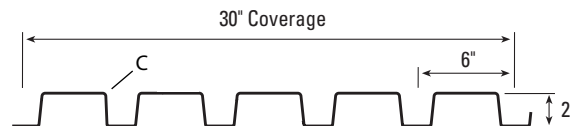
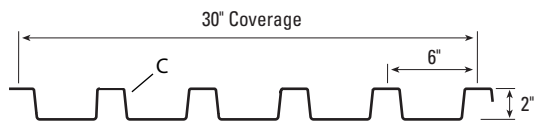

T2832 Roof

T2832 Wall

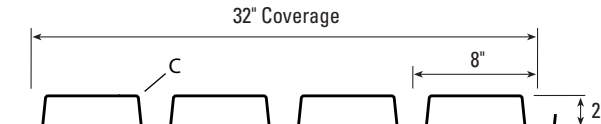
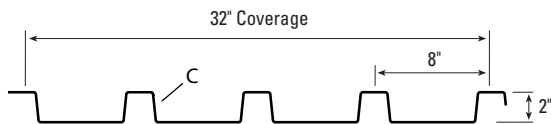

3" RIB Series

Rib Height 3"-4"

T13 Roof

T13 Wall

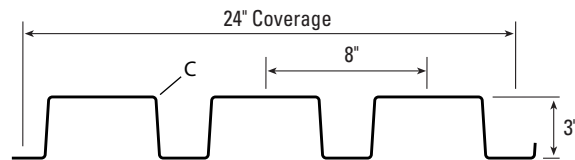
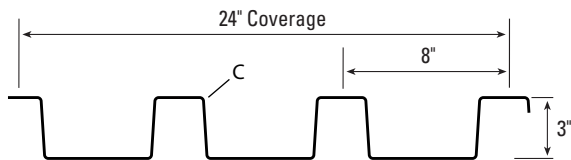

T13-A Roof

T13-A Wall

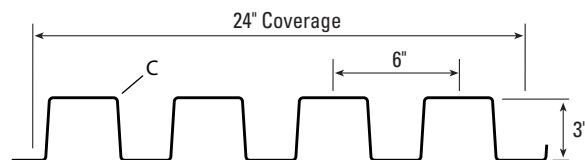
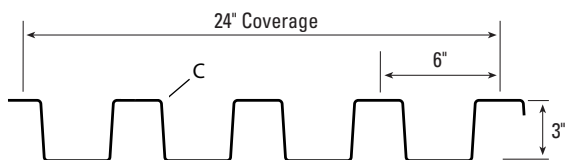

T13-B Roof

T13-B Wall

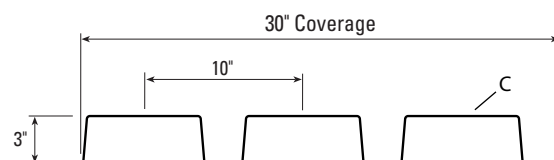
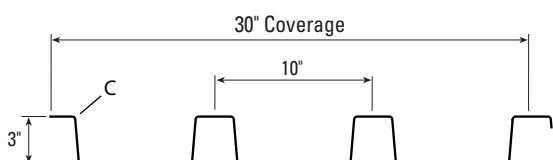

T14 Roof

T14 Wall

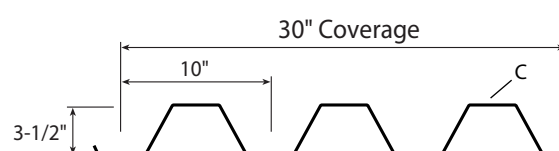
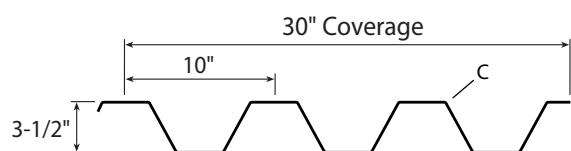

DEEP RIB Series

Rib Height 4" and Over

- ▶ Exposed direct-fastened panel for roof and wall applications
- ▶ Applies over open framing or solid substrate
- ▶ Various panel coverages
- ▶ 4" and 4-1/2" rib heights
- ▶ Trapezoidal ribs on various centers
- ▶ Optional material: stainless steel, aluminum and copper
- ▶ Gauges: 24 ga. standard, 22 ga., 20 ga. and 18 ga. optional
- ▶ Optional Aluminum: 0.032", 0.040" or 0.050"
- ▶ Minimum roof slope: 1:12
- ▶ Custom capabilities include:
 - Perforated panels for wind screens and liner panels
- ▶ Standard Finish: PVDF and Acrylic Coated Galvalume®
- ▶ Contact Metal Sales for load-carrying capabilities



TDR-6 Wall

T15 Roof

T15 Wall

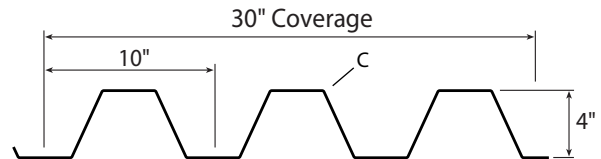
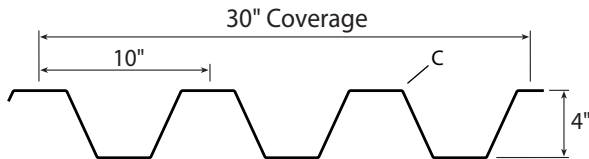

T25 Roof

T25 Wall

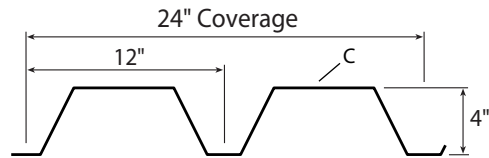
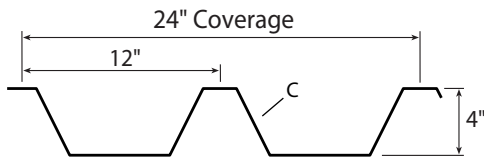

TDR-6 Roof

TDR-6 Wall

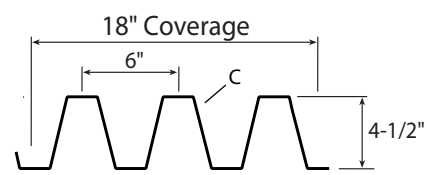
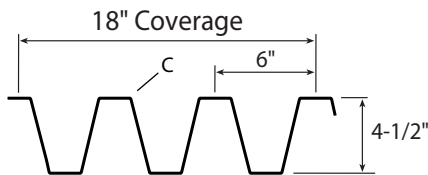

TDR-9 Roof

TDR-9 Wall

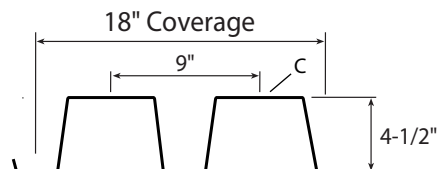
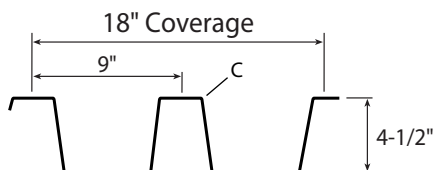

PBR-Panel, R-Panel

- ▶ Exposed direct-fastened panel for roof and wall applications
- ▶ 36" panel coverage
- ▶ Trapezoidal rib on 12" centers
- ▶ 1-1/4" rib height
- ▶ PBR-Panel Gauges: 26 ga. and 24 ga. standard, 22 ga. optional
- ▶ R-Panel Gauges: 26 ga. standard
- ▶ Minimum roof slope: 1:12
- ▶ Applies over open framing or solid substrate
- ▶ Finishes: MS Colorfast45[®], PVDF and Acrylic Coated Galvalume[®]
- ▶ Contact Metal Sales for load-carrying capabilities

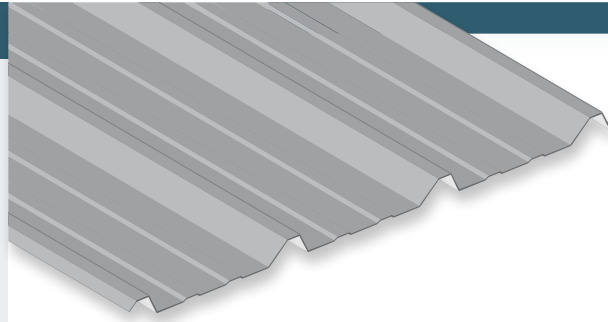

PBR-Panel

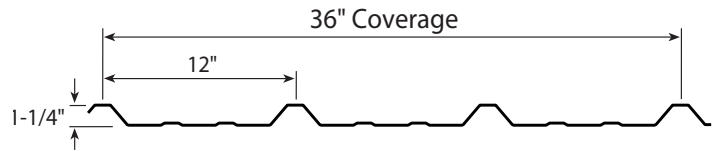

R-Panel

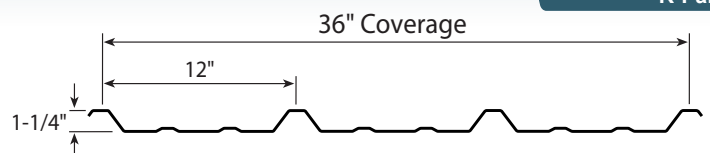

Testing and Approvals

- ▷ UL 580, Class 90 Wind Uplift, Construction, #161
- ▷ UL 790, Class A Fire Resistance Rating – per assembly
- ▷ UL 2218, Class 4 Impact Resistance
- ▷ ASTM E 455 Diaphragm Test
- ▷ Miami-Dade County Approved, NOA 20-0131.03 and 20-0131.02 (24 ga. roof & wall)
- ▷ Texas Department of Insurance Evaluation Reports, RC-198, RC-265, RC-279, RC-391
- ▷ ICC Evaluation Report, ESR-2385 (R-Panel)
- ▷ 2023 FBC Approved
 - 26 ga. over 16 ga. Purlins, FL10999.7
 - 26 ga. over 16 ga. Girts, FL9482.4
 - 26 ga. over 1/2" Plywood, FL14645.11



PBU-Panel, U-Panel

- ▶ Exposed direct-fastened panel for roof and wall applications
- ▶ 36" panel coverage
- ▶ Trapezoidal rib on 6" centers
- ▶ 3/4" rib height
- ▶ Gauges: 29 ga., 26 ga. and 24 ga. standard, 22 ga. optional
- ▶ Minimum roof slope: 1:12
- ▶ Applies over open framing or solid substrate
- ▶ Finishes: MS Colorfast45[®], PVDF and Acrylic Coated Galvalume[®]
- ▶ Contact Metal Sales for load-carrying capabilities

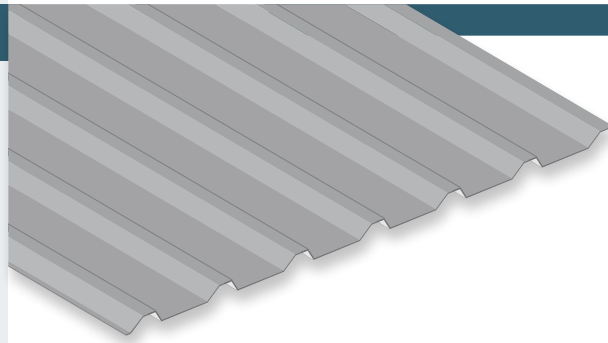

PBU-Panel

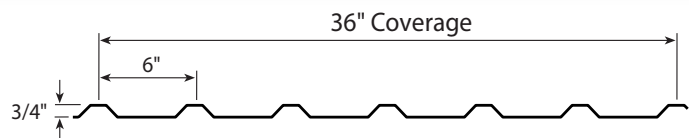

U-Panel

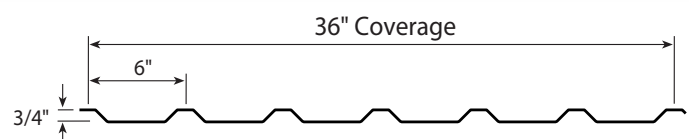

Testing and Approvals

- ▷ UL 263, Fire Resistance Rating – per assembly
- ▷ UL 580, Class 90 Wind Uplift, Construction, #39
- ▷ UL 790, Class A Fire Resistance Rating – per assembly
- ▷ UL 2218, Class 4 Impact Resistance
- ▷ Texas Department of Insurance Evaluation Report, RC-196
- ▷ ICC Evaluation Report, ESR-2385

Pro-Panel II®

- ▶ Exposed direct-fastened, low profile panel for roof and wall
- ▶ 36" panel coverage
- ▶ Trapezoidal rib on 9" centers
- ▶ 5/8" rib height
- ▶ Gauges: 29 ga. and 26 ga. standard
- ▶ Minimum roof slope: 3:12
- ▶ Applies over open framing or solid substrate
- ▶ Finishes: MS Colorfast45®, ColorFit40™, PVDF and Acrylic Coated Galvalume®
- ▶ Contact Metal Sales for load-carrying capabilities

Testing and Approvals

- ▶ UL 263, Fire Resistance Rating – per assembly
- ▶ UL 790, Class A Fire Resistance Rating – per assembly
- ▶ UL 2218, Class 4 Impact Resistance
- ▶ ASTM E 455 Diaphragm Test
- ▶ 2023 FBC Approved
- 29 ga. over 1/2" Plywood, 14645.12

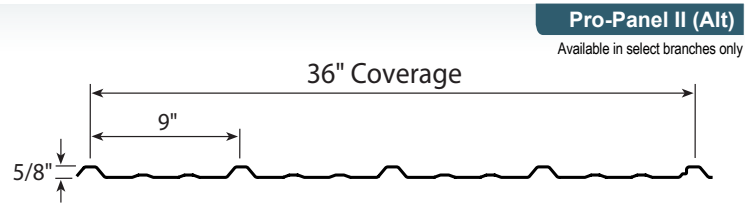
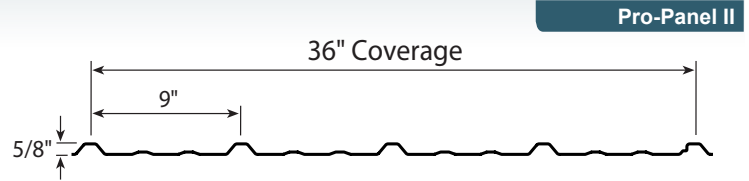
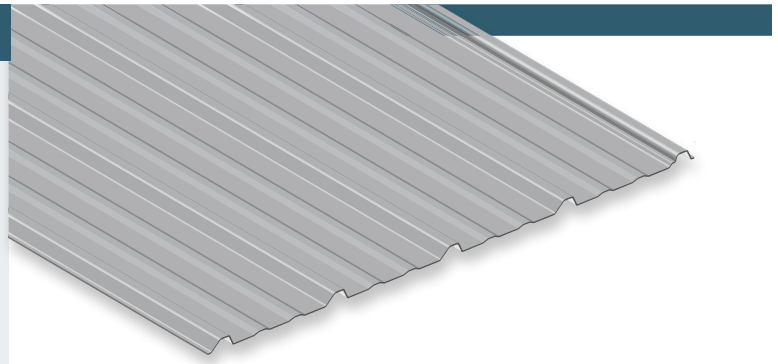

Classic Rib®

- ▶ Exposed direct-fastened, low profile panel for roof and wall
- ▶ 36" panel coverage
- ▶ Trapezoidal rib on 9" centers
- ▶ 3/4" bell-top rib height
- ▶ Gauges: 29 ga. and 26 ga. standard
- ▶ Minimum roof slope: 3:12
- ▶ Applies over open framing or solid substrate
- ▶ Finishes: MS Colorfast45®, ColorFit40™, Acrylic Coated Galvalume® and Galvanized
- ▶ Contact Metal Sales for load-carrying capabilities

Testing and Approvals

- ▶ UL 263, Fire Resistance Rating – per assembly
- ▶ UL 580, Class 90 Wind Uplift, Construction, #560 and 584
- ▶ UL 790, Class A Fire Resistance Rating – per assembly
- ▶ UL 2218, Class 4 Impact Resistance
- ▶ ASTM E 455 Diaphragm Test
- ▶ ASTM E 564-95 Diaphragm Test
- ▶ Miami-Dade County Approved, NOA 21-0629.10
- ▶ Texas Department of Insurance Evaluation Reports, RC-161 and RC-391
- ▶ ICC Evaluation Report, ESR-2385
- ▶ 2023 FBC Approved
 - 29 ga. over 2x Purlins, FL10999.4
 - 29 ga. over 2x Girts, FL9482.3
 - 29 ga. over 7/16" OSB, FL14645.8
 - 29 ga. over 1/2" Plywood, FL14645.9
 - 29 ga. over 1/2" Plywood, FL14645.6
 - 26 ga. over 5/8" Plywood, FL14645.7
 - 26 ga. over 16 ga. Girts, FL9482.2
 - 26 ga. over 16 ga. Purlins, FL10999.3
 - 0.032" Alum over 7/16" OSB, FL14645.5

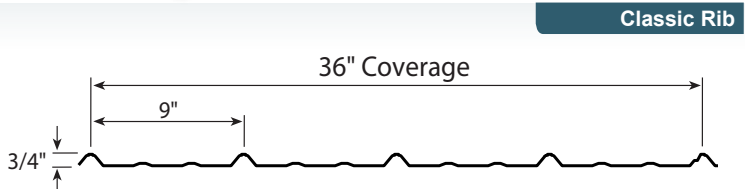
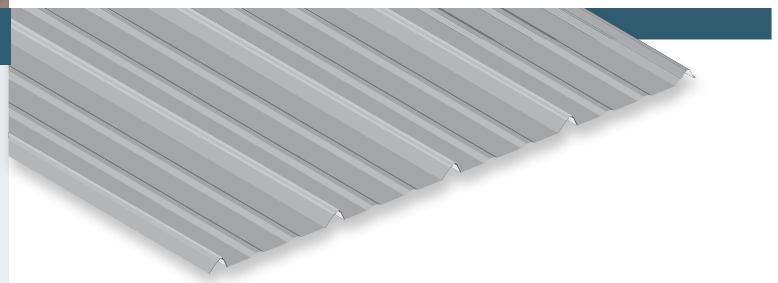

1.25" Corrugated

- ▶ Exposed direct-fastened panel for roof and wall applications
- ▶ 24" panel coverage
- ▶ Corrugated ribs on 1-1/4" centers
- ▶ 1/4" rib height
- ▶ Gauges: 29 ga. and 26 ga. standard
- ▶ Minimum roof slope: 3:12
- ▶ Applies over open framing or solid substrate
- ▶ Finishes: MS Colorfast45® and Acrylic Coated Galvalume®
- ▶ Contact Metal Sales for load-carrying capabilities

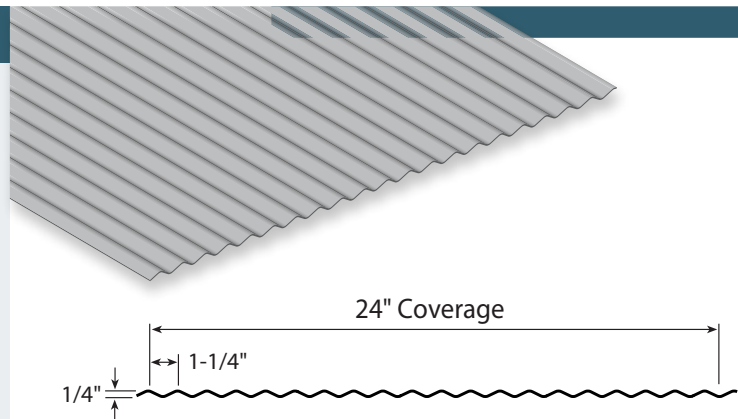

Testing and Approvals

- ▷ UL 263, Fire Resistance Rating — per assembly
- ▷ UL 580, Class 90 Wind Uplift, Construction, #161
- ▷ UL 790, Class A Fire Resistance Rating — per assembly
- ▷ UL 2218, Class 4 Impact Resistance



2.5" Corrugated

- ▶ Exposed direct-fastened panel for roof and wall applications
- ▶ 24" panel coverage (wall)
- ▶ 21-1/3" panel coverage (roof)
- ▶ Corrugated ribs on 2-2/3" centers
- ▶ 1/2" rib height
- ▶ Gauges: 29 ga. and 26 ga. standard
- ▶ Minimum roof slope: 3:12
- ▶ Applies over open framing or solid substrate
- ▶ Finishes: MS Colorfast45® and Acrylic Coated Galvalume®
- ▶ Contact Metal Sales for load-carrying capabilities

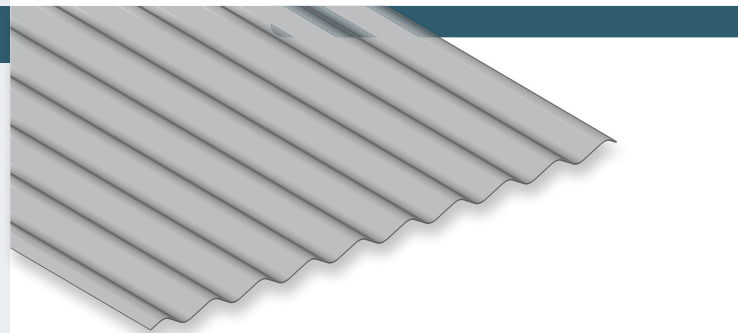

Roof

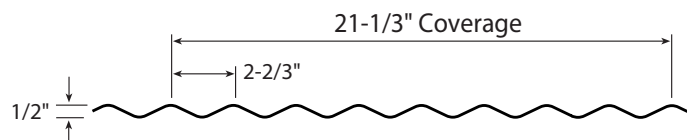

Wall

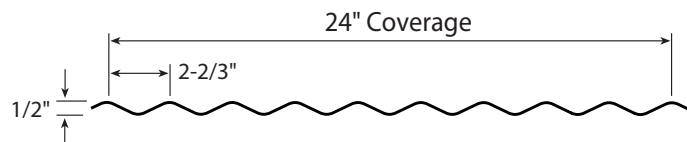

Testing and Approvals

- ▷ UL 263, Fire Resistance Rating — per assembly
- ▷ UL 790, Class A Fire Resistance Rating — per assembly
- ▷ UL 2218, Class 4 Impact Resistance
- ▷ Texas Department of Insurance Evaluation Report, RC-159
- ▷ ICC Evaluation Report, ESR-2385
- ▷ 2023 FBC Approved
-26 ga. over 5/8" Plywood, FL14645.1



Strongpanel®

- ▶ Exposed direct-fastened roof and wall panel
- ▶ 36" panel coverage
- ▶ 5/8" rib height
- ▶ Classic board and batten design, on 9" centers
- ▶ Gauges: 29 ga. and 28 ga. standard
- ▶ Minimum roof slope: 3:12
- ▶ Applies over open framing or solid substrate
- ▶ Finishes: MS Strongcoat45® and Galvanized
- ▶ Contact Metal Sales for load-carrying capabilities

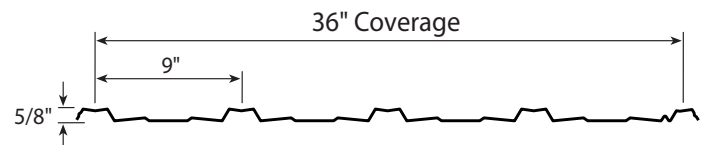
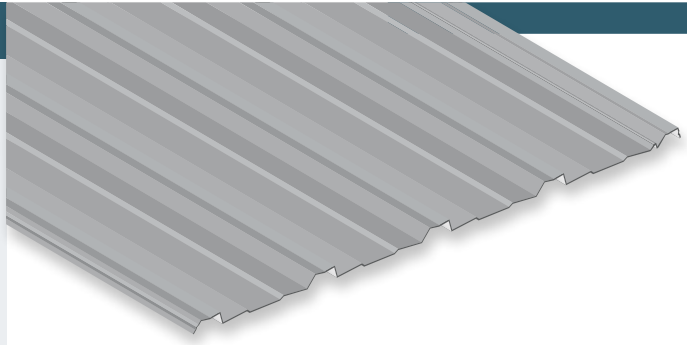

Testing and Approvals

- ▶ UL 263, Fire Resistance – per assembly
- ▶ UL 580, Class 90 Wind Uplift, Construction, #161
- ▶ UL 790, Class A Fire Resistance Rating – per assembly
- ▶ UL 2218, Class 4 Impact Resistance
- ▶ Texas Department of Insurance, RC-405 and RC-406



DL-3 Panel

- ▶ Exposed direct-fastened panel for roof and wall applications
- ▶ 36" panel coverage
- ▶ .39" rib height
- ▶ Trapezoidal ribs on 3" centers
- ▶ Gauges: 29 ga. standard
- ▶ Minimum roof slope: 3:12
- ▶ Applies over open framing or solid substrate
- ▶ Finishes: MS Colorfast45® and Bare Galvanized
- ▶ Contact Metal Sales for load-carrying capabilities

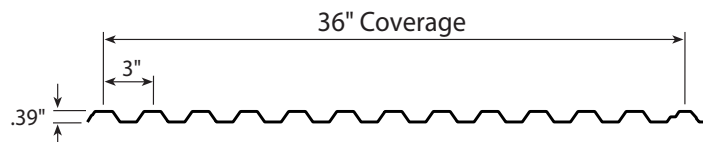
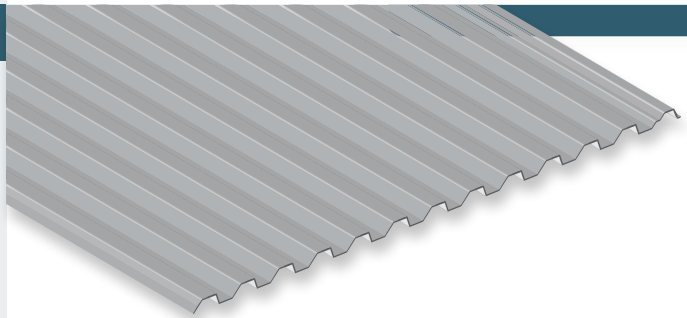

Testing and Approvals

- ▶ ASTM E 1592 Structural Performance



Bi-Rib

- ▶ Exposed direct-fastened panel for roof and wall applications
- ▶ 36" panel coverage
- ▶ 7/16" rib height
- ▶ Double trapezoidal ribs on 9" centers
- ▶ Gauges: 29 ga. and 26 ga. standard
- ▶ Minimum roof slope: 3:12
- ▶ Applies over open framing or solid substrate
- ▶ Finishes: MS Colorfast45® and Acrylic Coated Galvalume®
- ▶ Contact Metal Sales for load-carrying capabilities

Testing and Approvals

- ▶ UL 263, Fire Resistance – per assembly
- ▶ UL 790, Class A Fire Resistance Rating – per assembly
- ▶ UL 2218, Class 4 Impact Resistance

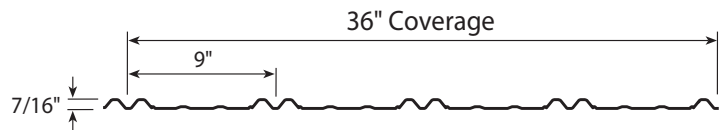
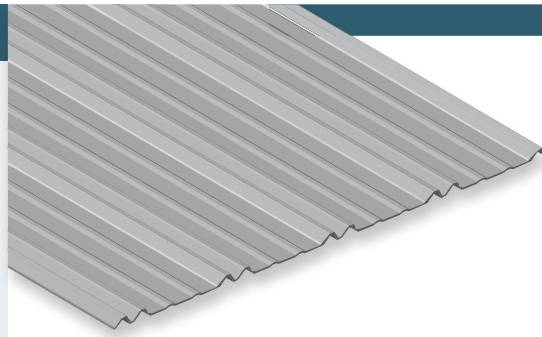

Delta Rib

- ▶ Exposed direct-fastened panel for roof and wall applications
- ▶ 24" panel coverage
- ▶ 13/16" rib height
- ▶ Trapezoidal rib on 8" centers
- ▶ Gauges: 29 ga. and 26 ga. standard
- ▶ Minimum roof slope: 3:12
- ▶ Applies over open framing or solid substrate
- ▶ Finishes: MS Colorfast45® and Acrylic Coated Galvalume®
- ▶ Contact Metal Sales for load-carrying capabilities

Testing and Approvals

- ▶ UL 263, Fire Resistance Rating – per assembly
- ▶ UL 790, Class A Fire Resistance Rating – per assembly
- ▶ UL 2218, Class 4 Impact Resistance

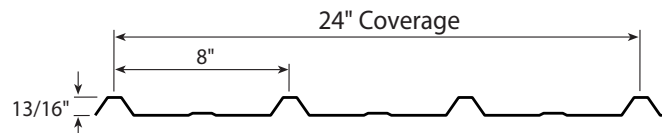
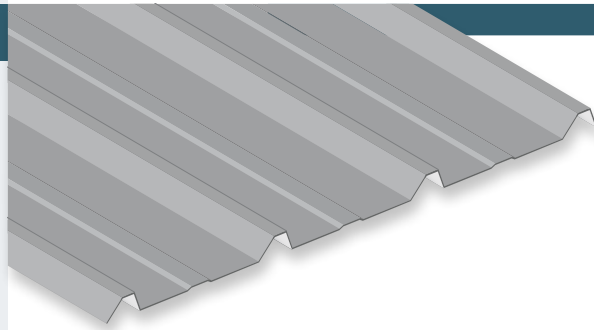

Dual Rib

- ▶ Diamond-Embossed Aluminum - Mill Finished
- ▶ Diamond-Embossed Aluminum - White
- ▶ Exposed direct-fastened, low profile panel for roof and wall
- ▶ 36" panel coverage
- ▶ 3/4" bell-top rib height
- ▶ Twin trapezoidal ribs on 9" centers
- ▶ Substrate: Aluminum
- ▶ Thickness: 0.018" (before embossing)
- ▶ Minimum roof slope: 3:12
- ▶ Contact Metal Sales for load-carrying capabilities

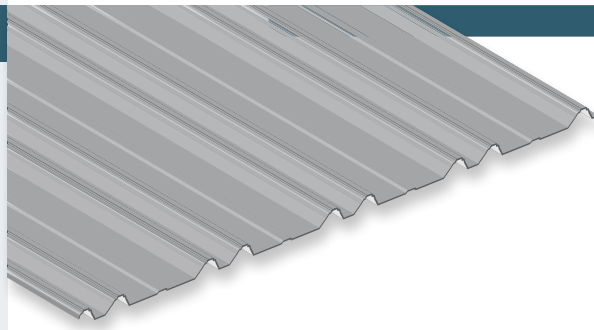

Only available at select branches. Please inquire.

IMPower Series™

- ▶ Insulated metal wall and roof systems
- ▶ Factory-injected foam insulation between dual steel facings
- ▶ Closed cell insulating core provides approximately R-8 per inch
- ▶ Panel Coverage: 40"
- ▶ Wall Panel Thickness: 2", 2.5", 3" and 4"
- ▶ Roof Panel Thickness: 2.5", 3.25", 4", 5" and 6"
- ▶ Gauges: 26 ga. standard 24 ga. and 22 ga. optional
- ▶ Finishes: PVDF and SMP coatings
- ▶ Contact Metal Sales for load-carrying capabilities

Testing and Approvals

- ▷ ASTM E 283 Air Infiltration
- ▷ ASTM E 331 Water Penetration
- ▷ ASTM E 1646 Water Penetration
- ▷ ASTM E 1680 Air Leakage

DM40 Double Mesa Wall

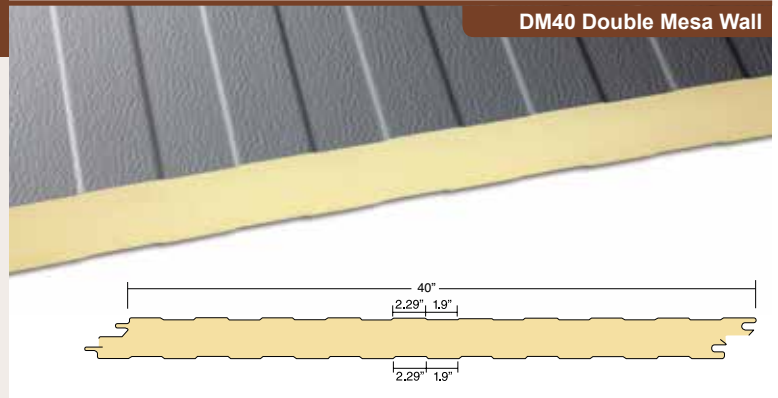

FL40 Flat Wall

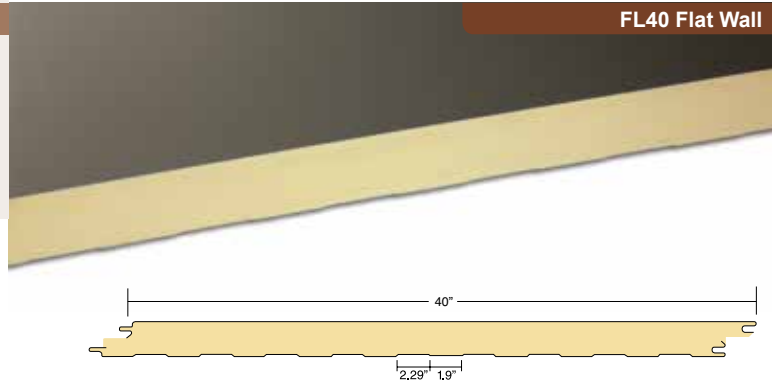

SR2 Standing Seam Roof

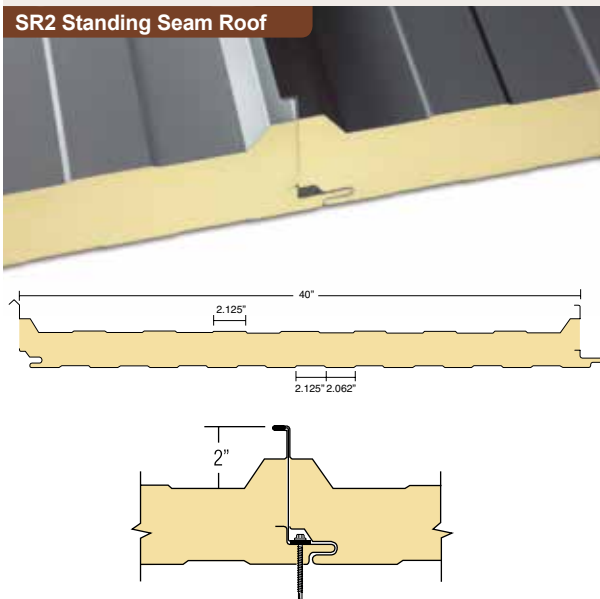

HE40 Heavy Embossed Wall

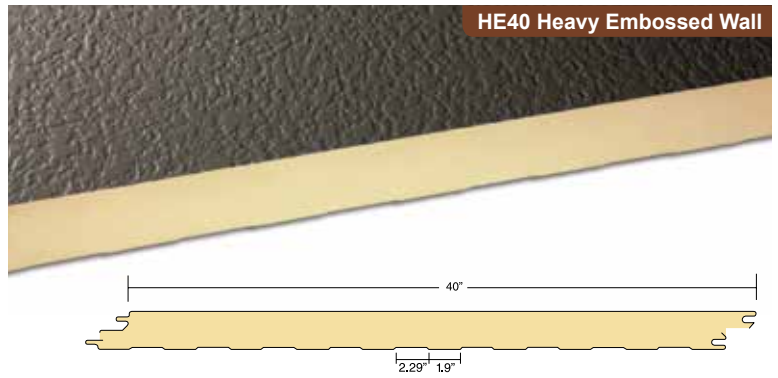

HE40A AdobeTexture™ Wall

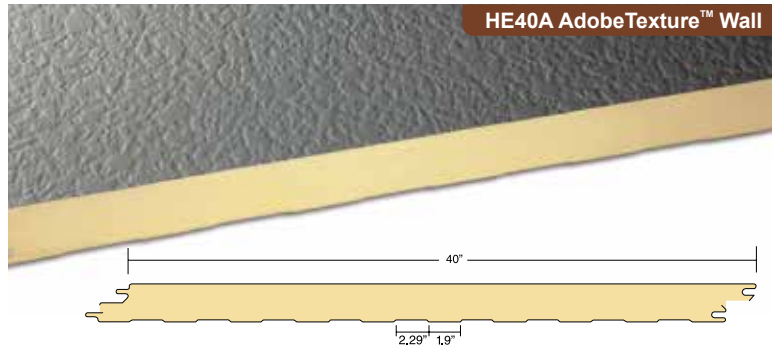

HR3 High Rib Roof

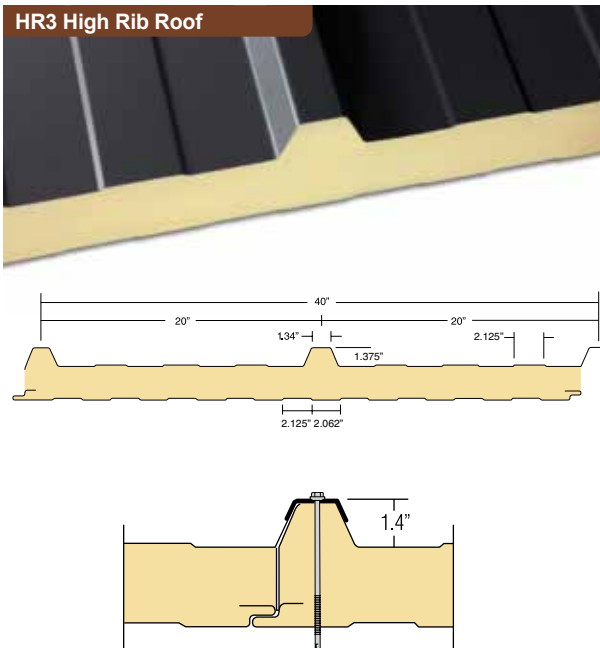

ST40 Striated Wall

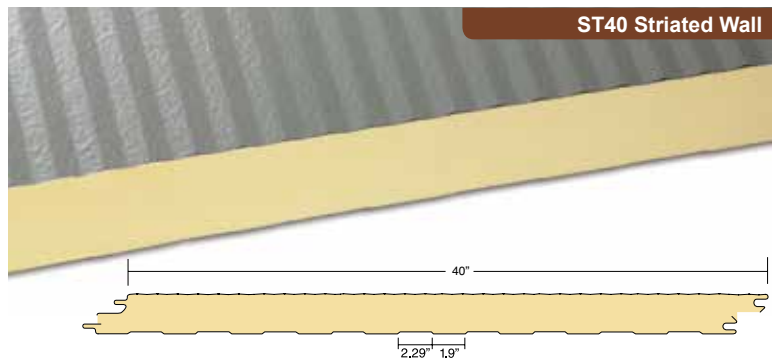



Cold-Formed
Bolt-Up
Steel Building
Solutions

Find out how easy it is to instantly provide your customers with a building design, cost estimate, construction contract, blueprints and more.

Metal Sales IMPACT Steel Building program brings you a powerful, free software tool that allows you to sit down with your customers and help them design their next steel building from the ground up.

There's never been a better, faster and more appreciated way to help your customers than by saving them all the problems and inconvenience of designing and erecting a custom building from scratch. From engineered foundation designs to steel supply at the job site, IMPACT has it all covered.

Why Cold-Formed Steel Buildings?

A cold-formed steel building is any building constructed with cold-formed steel and CEE sections that are bolted or screwed together to form clear span frames, columns and rafters. No welding is required.

Advantages of Cold-Formed Steel

- ▶ High strength-to-weight ratio
- ▶ Non-combustibility
- ▶ Termite resistant
- ▶ Ease of construction

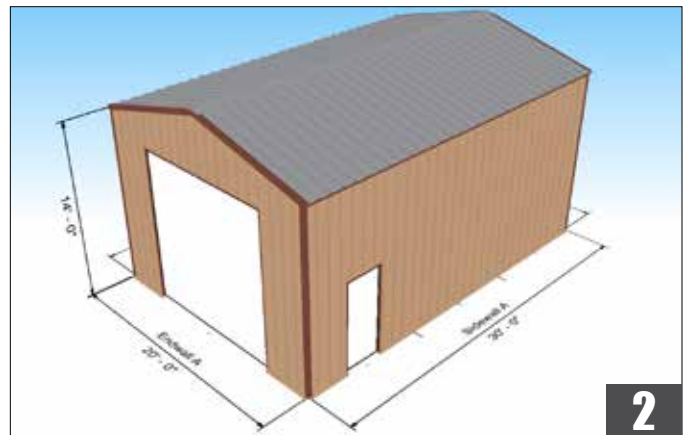
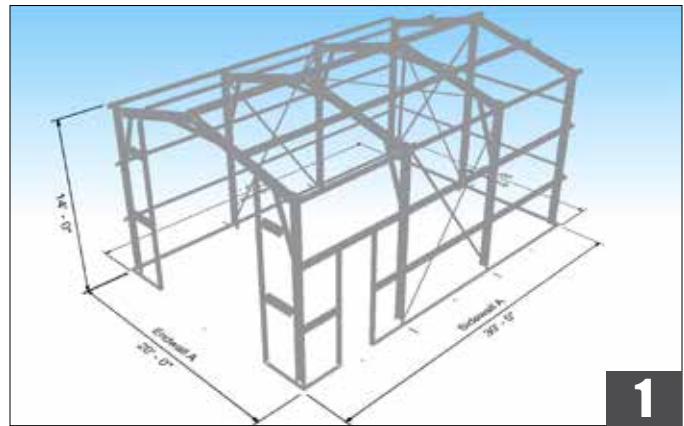

Self Storage Solutions

Metal Sales can offer you the flexibility to quote a wide variety of shapes and sizes. With our panels and flashings pre-loaded into the software, MBS allows for quick and easy building data input resulting in a complete Self Storage building solution. Contact Metal Sales for custom building designs.



Powered by MBS, the number one Self Storage software program in the United States. Trusted by over 200 metal building manufacturers.

The MBS program automatically prepares erection drawings unique to each building inputted, including Anchor Bolt Plans.



A stamped Engineer Seal is available for the erection drawings upon request. Contact Metal Sales for the latest testing and approval information.

Trained Metal Sales team members will work with you to take your self storage building concepts and make them a reality.



Secondary Framing

- ▶ Ceess and Zees 4" to 12" deep with 2-1/2" to 4" flange widths
- ▶ Gauges: 10, 12, 14 or 16
- ▶ Symmetrical and asymmetrical flanges
- ▶ Red Oxide finish ASTM A 1011 Grade 50, Class 2 (55 ksi min yield)
- ▶ Galvanized finish ASTM A 653 Grade 50, Class 2 (55 ksi min yield)
- ▶ Single Slope Eave Struts for high-side applications
- ▶ Double Slope Eave Struts for low-side applications

Other Components are available. Please inquire.



CEES, ZEES AND EAVE STRUTS

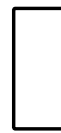

Cee

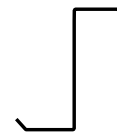

Equal Leg Zee

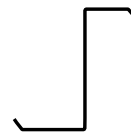

Lap Zee

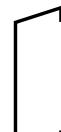

Single Slope



Double Slope



Universal

CHANNELS, HAT SECTIONS AND ANGLES

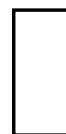

Channel



1-1/2" Channel



1-1/4" Hat Section

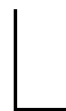

Angle



3/4" Sub-girt



1-1/2" Hat Section

Retro-Master® System

Solutions for existing flat roofs

Retro-Master® is a complete retrofit roof system that easily and affordably transforms old and failing roofs into a new code-compliant and energy-efficient sloped metal roof.

- ▶ Added slope minimizes maintenance flat roof and geometry problems
- ▶ Roofing systems designed for a longer life cycle
- ▶ In-house engineering and design assistance available

As a single-source solution Retro-Master® retrofit roof system is backed by a 20 year weathertight warranty and an industry-leading 45 year paint finish warranty. It is the ideal solution for schools, universities, retail centers, industrial or office building, military or any other building needing a new, long-lasting, high performance roof.

Post-Purlin over failing flat roof

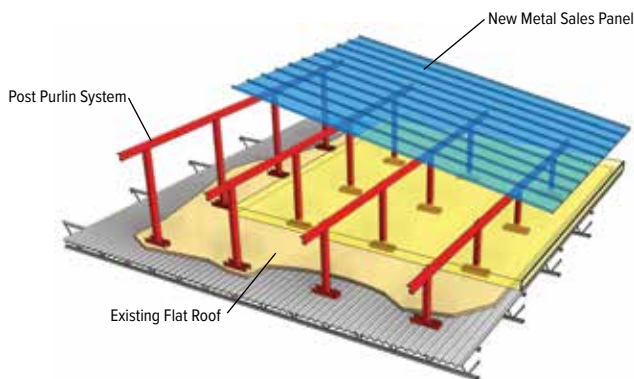

NEW METAL ROOF PANELS OVER EXISTING FLAT ROOF.

Post-Purlin Retrofit System

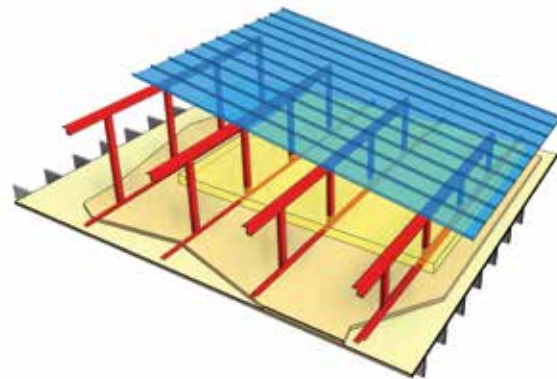

RETRO-MASTER SYSTEM OVER WOOD SUBSTRATE

Post-Purlin over Concrete Substrate

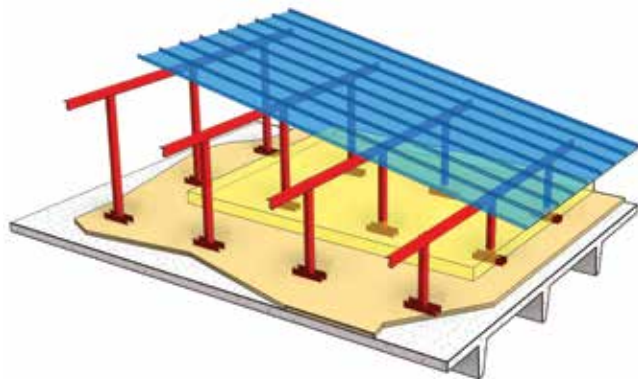

RETRO-MASTER SYSTEM OVER CONCRETE SUBSTRATE



Roof Hugger™ System

Solutions for existing sloped metal roofs

If your building has an existing sloped metal roof in need of replacement, Roof Hugger™ is the most complete and convenient solution. This easy, efficient and virtually waste-free system is installed over your existing roof, allowing your business to operate uninterrupted and allowing the option to install new insulation if needed.

This Metal-Over-Metal Reroof Solution combines high quality Metal Sales roof panels with a patented Roof Hugger™ sub-purlin retrofit framing system to deliver a new, structurally sound roof that will stand the test of time.

NEW METAL ROOF PANELS OVER EXISTING SLOPED METAL PANELS



Perforation

- ▶ Perforated panels are an aesthetic design solution
- ▶ Wide array of panel profiles
- ▶ Available gauges: 24, 22, 20 or 18
- ▶ Windscreens, balcony railings, equipment and concealment screens, ventilation and interior liner



Mitered Corners

- ▶ Non-Insulated panels up to 3" deep
- ▶ Vertical & Horizontal applications
- ▶ Profile widths or modules up to 36"
- ▶ +/- 90 Degrees (Inside – Outside – Double Corners)
Corner leg dimensions up to 4'-0" in either direction

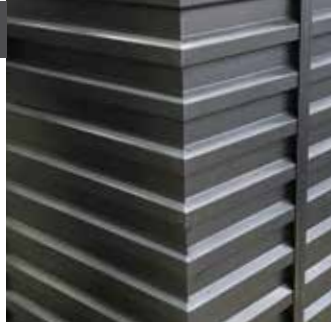

Coating Systems

Meet or exceed codes and standards

Our advanced coating technology ensures Metal Sales finishes and colors meet demonstrated energy performance requirements established by ENERGY STAR® and the Cool Roof Rating Council (CRRC) for solar reflectance and thermal emittance for steep sloped and/or low sloped buildings.

Benefits of cool colors

Cool roof colors are offered from an engaging palette of light neutrals to dark saturated hues that respect the environment and help achieve your vision. Cool roofs may also contribute to other strategies for optimizing energy performance. Energy savings and other direct benefits are contingent upon building type, location and use.

Substrate Materials

Our line of durable materials includes steel, stainless steel, weathering steel, copper and aluminum. Your Metal Sales representative has technical information on material and coating compatibility.

TOP COAT

Exceptional color durability and gloss retention

PRIMER

Corrosion resistance and bonding

PRETREATMENT

Adhesion, moisture and corrosion protection

GALVALUME/GALVANIZED

Inhibits corrosion

BARE STEEL

Mill certified to meet ASTM standards

GALVALUME/GALVANIZED

Inhibits corrosion

PRETREATMENT

PRIMER

BACK COAT

Covers primer and ensures consistent color

Metal Sales Branch Locations



ANCHORAGE, ALASKA

4625 Old Seward Highway
Anchorage, AK 99503
866.640.7663 ■ 907.646.7664/Fax

BAY CITY, MICHIGAN

5209 Mackinaw Road
Bay City, MI 48706
888.777.7640 ■ 888.777.0112/Fax

DEER LAKE, PENNSYLVANIA

29 Pinedale Industrial Road
Orwigsburg, PA 17961
800.544.2577 ■ 800.544.2574/Fax

DENVER, COLORADO

7990 East I-25, Frontage Road
Longmont, CO 80504
800.289.7663 ■ 800.289.1617/Fax

DETROIT LAKES, MINNESOTA

1435 Egret Avenue
Detroit Lakes, MN 56501
888.594.1394 ■ 888.594.1454/Fax

FONTANA, CALIFORNIA

14213 Whittram Avenue
Fontana, CA 92335
800.782.7953 ■ 909.829.9083/Fax

FORT SMITH, ARKANSAS

7510 Ball Road
Fort Smith, AR 72908
877.452.3915 ■ 479.646.5204/Fax

INDEPENDENCE, MISSOURI

1306 South Powell Road
Independence, MO 64057
800.747.0012 ■ 800.409.3069/Fax

JACKSONVILLE, FLORIDA

7110 Stuart Avenue
Jacksonville, FL 32254
800.394.4419 ■ 800.413.3292/Fax

JEFFERSON, OHIO

352 East Erie Street
Jefferson, OH 44047
800.321.5833 ■ 800.233.5719/Fax

KELSO, WASHINGTON

2680 Coweeman Park Drive
Kelso, WA 98626
800.431.3470 ■ 253.872.2008/Fax

MOCKSVILLE, NORTH CAROLINA

188 Quality Drive
Mocksville, NC 27028
800.228.6119 ■ 800.228.7916/Fax

NASHVILLE, TENNESSEE

4314 Hurricane Creek Boulevard
Antioch, TN 37013
800.251.8508 ■ 800.419.4372/Fax

NEW ALBANY, INDIANA

999 Park Place
New Albany, IN 47150
812.944.2733 ■ 812.944.1418/Fax

ROCK ISLAND, ILLINOIS

8111 29th Street West
Rock Island, IL 61201
800.747.1206 ■ 309.787.1833/Fax

ROGERS, MINNESOTA

22651 Industrial Boulevard
Rogers, MN 55374
800.328.9316 ■ 800.938.9119/Fax

SELLERSBURG, INDIANA

7800 Highway 60
Sellersburg, IN 47172
800.999.7777 ■ 800.477.9318/Fax

SIoux FALLS, SOUTH DAKOTA

2700 West 3rd Street
Sioux Falls, SD 57104
888.299.0024 ■ 888.960.0429/Fax

SPOKANE, WASHINGTON

2727 East Trent Avenue
Spokane, WA 99202
800.572.6565 ■ 509.534.4427/Fax

TEMPLE, TEXAS

3838 North General Bruce Drive
Temple, TX 76501
800.543.4415 ■ 800.543.4473/Fax

WOODLAND, CALIFORNIA

1326 Paddock Place
Woodland, CA 95776
800.759.6019 ■ 530.668.0901/Fax