



Top 10 **Exotic** Free Energy Technologies

By Sterling D. Allan, CEO, PES Network, Inc., New Energy Congress
Earth Transformation Conference, Kona, Hawaii, USA; Jan. 8, 2010

Available Online

This PowerPoint presentation
can be downloaded for free
from PESWiki.com
keyword: "Earth Transformation"

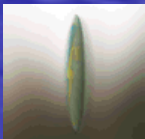

IMAGINE



Imagine a world in which each home has its own power generator that obtains its energy in such a way that no fuel has to be added. Imagine every vehicle being able to run without ever stopping for fuel. Imagine each appliance having its own power source that never has to be recharged. That is the world of the future. Join with us now as we track our progress toward such a world.

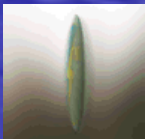

Outline

- “Free Energy”
- Basis for Determination
- Top 10
- Runners Up
- Open Sourcing

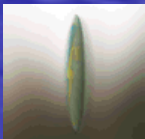

Things could be worse

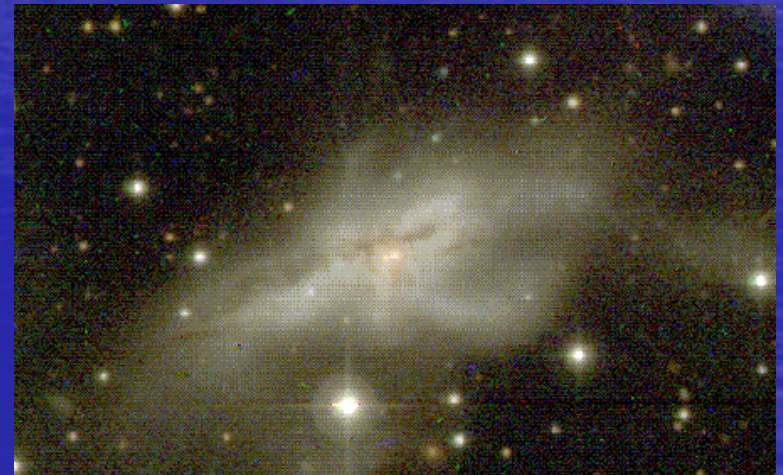

Ideal Energy Device

- **Affordable**
- Renewable, Non-depleting
- Environmentally Friendly
- **Continuous Output**
- **Load-following**
- Robust, Low Maintenance
- Scalable
- **Portable**
- Materials are Sustainable
- Practical
- *Strong Team*



"Impossible"

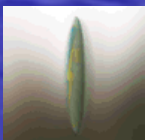
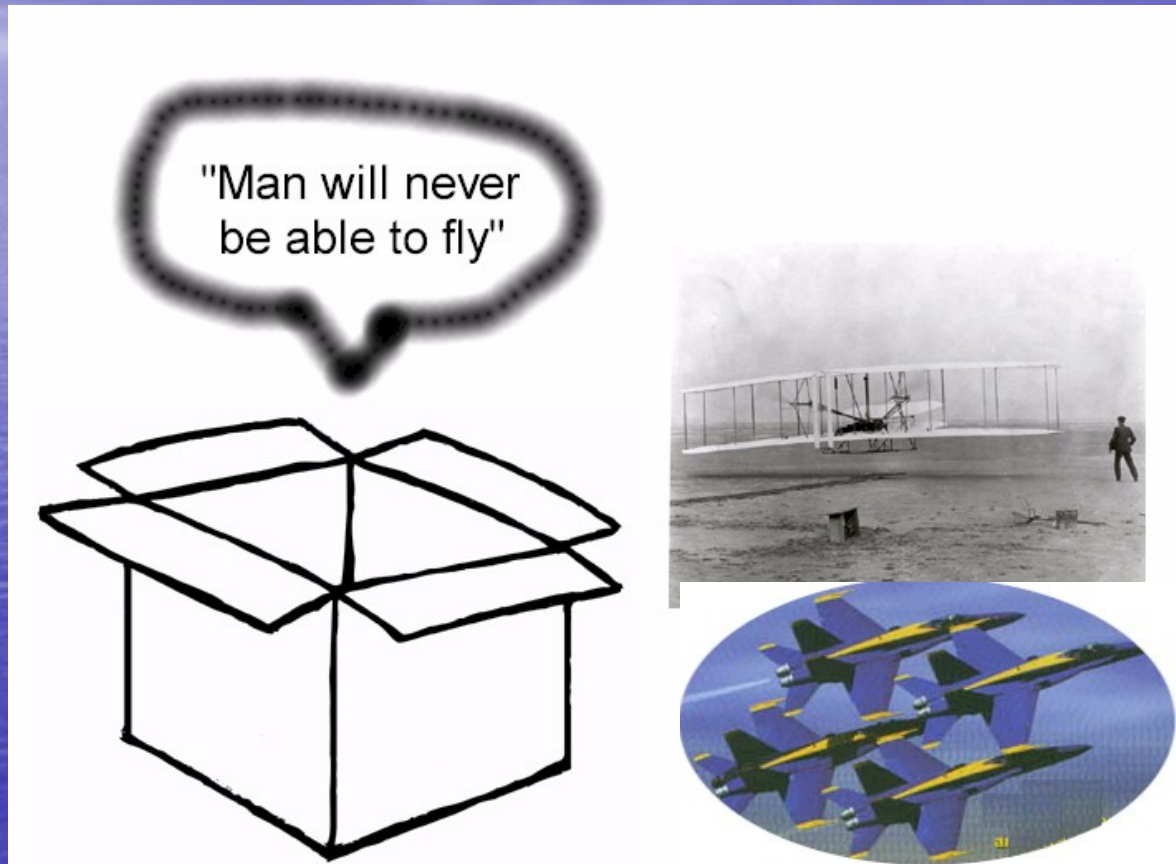

It's Not Perpetual Motion

When we say “free energy”, we’re referring to harvesting sources that are free for the taking, and renewable.

Just because it appears to be coming from “nowhere” doesn’t mean there isn’t some unseen mechanism in play.

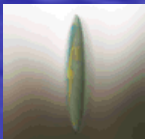

Evolution of Ideas

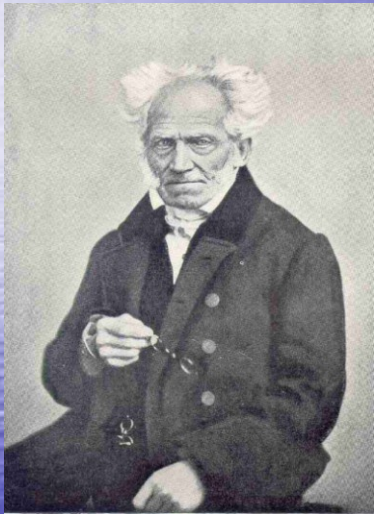

**All truth passes through three stages:
First, it is ridiculed;
Second, it is violently opposed; and
Third, it is accepted as self-evident.--
*Arthur Schopenhauer (1788-1860)***

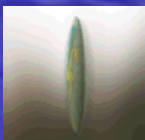

Crackpot?

**"When you're one step ahead
of the crowd you're a genius.
When you're two steps ahead,
you're a crackpot."**

-- Rabbi Shlomo Riskin, (Feb. 1998)

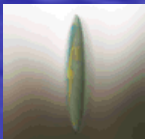

“Crackpots” & Eccentrics

Sterling’s Axiom:

Generally speaking, one’s eccentricity is directly proportional to the distance one is outside the box.

- **Mavericks**, being outcasts from the mainstream, don’t develop the same social skills as their peers.
- **Interpersonal conflicts** are the GREATEST IMPEDIMENT to the progress of exotic technologies to the marketplace.
- This eccentricity syndrome contributes to the stigma of “crackpot” by others.
- This phenomenon holds true in any field of endeavor: alt energy, alt health, UFOlogy, etc.*

*Some might argue that “electricity contributes to eccentricity”.

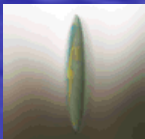

Ideal Energy Device

- **Affordable**
- Renewable, Non-depleting
- Environmentally Friendly
- **Continuous Output**
- **Load-following**
- Robust, Low Maintenance
- Scalable
- **Portable**
- Materials are Sustainable
- Practical
- *Strong Team*

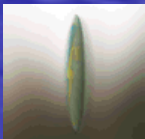

Cost of Energy: Oil vs. Renewable

Crude Oil Prices 1998 – 2009

(West Texas Intermediate – monthly averages)

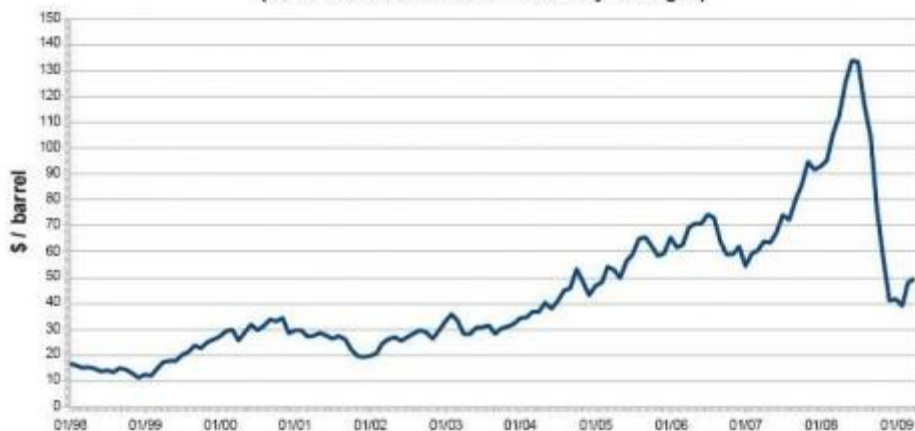

© Maximilian A. Staedler [Maximilian A. Staedler] – WHAT MATTERS WEBLOG – www.whatmattersweblog.com – source: EIA

<http://economatters.wordpress.com/2009/05/16/why-oil-prices-are-bound-to-rise/>

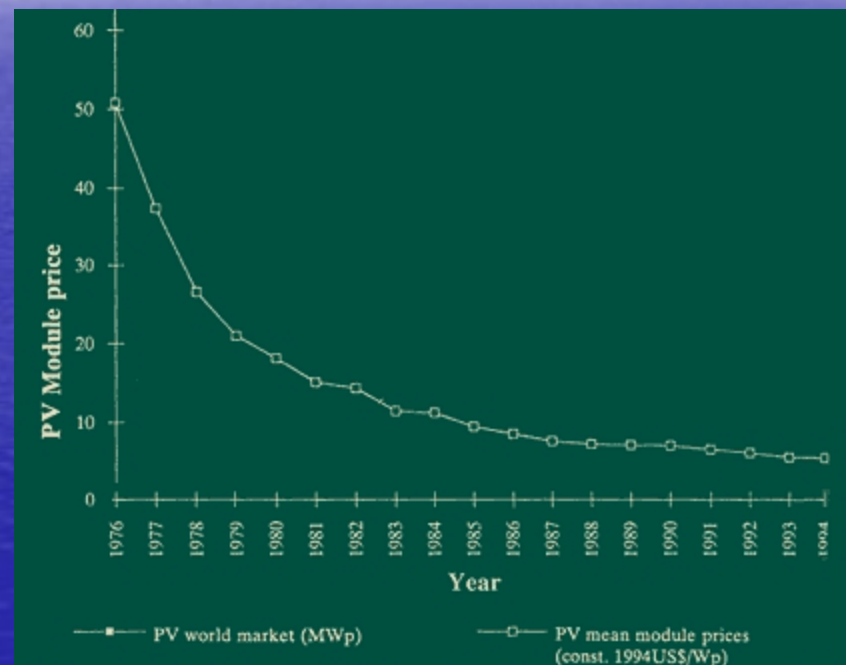

Figure 1: PV Mean Module Prices and PC Market. (National Renewable Energy Laboratory. (1995). Photovoltaic energy program overview: fiscal year 1994 Series 1-12. Washington: Department of Energy Laboratories.)

<http://www.eco-web.com/editorial/031012.html>

Top 10 Exotic Free Energy Technologies

Sterling D. Allan, New Energy Congress (.org)

<http://FreeEnergyNews.com>

<http://PESWiki.com>

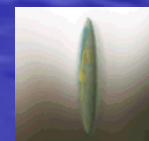



“Free Energy”



- Conventional

- Solar
- Wind
- Geothermal
- Tide
- Etc.

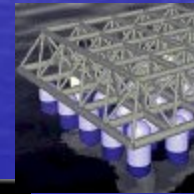
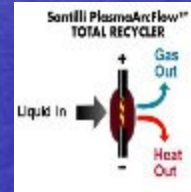
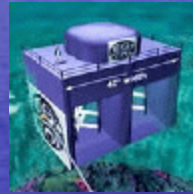

- Exotic

- Cold Fusion
- Magnet Motors
- Electromagnetic “Over Unity”
- Water Power

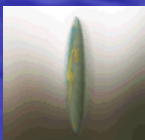
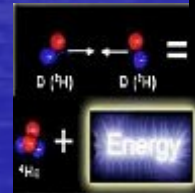

Free Energy Genres that Work

Conventional

- Hydro
- Wind
- Solar
- Geothermal (Turbine & Mass)
- Waste-to-Energy
- Biomass/Biofuels
- Low-impact hydro: Run-of-River
- Thermal Electric
- Tide
- Ocean Wave
- Ocean Thermal
- Environmental Vibrations

Exotic

- Cold Fusion
- Magnet Motors
- Electromagnetic "Over Unity"
- Super Efficient Water Electrolysis
- Brown's Gas
- GEET Reactor
- Vortex
- Cavitation
- Ball Lighting
- Joe Cell / Orgone
- Electrostatic
- Zero Point Energy

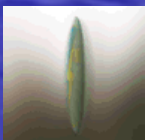

Top 10 **Exotic** Technologies -- Determining Factors

Qualifications and Considerations

- Prior credentials as “maverick” in religio-political and UFO arenas since 1996
- Free Energy News and Directory service for nearly 8 years (clearing house)
- New Energy Congress ranking Top 100 Clean Energy Technologies 4 years
- Criteria for establishing ideal energy device
- Building own renewable home and intentional community (personal)
- Some direct and indirect personally beneficial relationships (bias)



Intentional Community

<http://SafeHavenVillages.org>



I'm involved with a group of people who are preparing to build an intentional community based on principles of sustainability, healthy living, natural healing, individual responsibility, cooperation, and renewable energy. In short, it is about alternative, enlightened everything.

http://peswiki.com/index.php/OS:Utah_Safe_Haven_Village_Project



Top 10 Exotic Free Energy Technologies

Sterling D. Allan, New Energy Congress (.org)

<http://FreeEnergyNews.com>

<http://PESWiki.com>

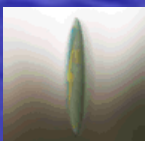

New Energy Congress

<http://peswiki.com/index.php/Congress:Join>

The New Energy Congress is a global association of experts who review the most promising new and emerging energy technologies. We publish [The Global Top 100 Clean Energy Technologies](#) list, a publically available resource that is generated from a continuous professional review process taking into consideration a number of criteria including: environmental impact, sustainability, cost benefits, reliability, scalability, safety, and availability. We also facilitate the emergence of promising new technologies that may have difficulty gaining assistance through more traditional means.



Top 10 Exotic Free Energy Technologies

Sterling D. Allan, New Energy Congress (.org)

<http://FreeEnergyNews.com>

<http://PESWiki.com>

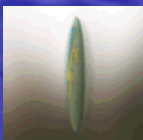

10 Technology Review Criteria

New Energy Congress

- Renewable
- Environmental Impact
- Affordable
- Credible
- Reliable
- Implementation
- Safety
- Politics of Science
- Open Source Friendly
- Stage of Development

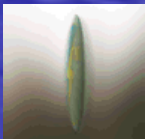

Ideal Energy Device

- **Affordable**
- Renewable, Non-depleting
- Environmentally Friendly
- **Continuous Output**
- **Load-following**
- Robust, Low Maintenance
- Scalable
- **Portable**
- Materials are Sustainable
- Practical
- *Strong Team*

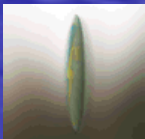

<http://Top100Energy.com>

- 1 Stirling Energy Systems - utility concentrated solar
- 2 Cyclone Technologies Schoell Cycle Engine
- 3 Solar Hydrogen Energy Corporation (SHEC)
- 4 Raser Rapidly Deployable Cost-Effective Geothermal
- 5 Colliding Plasma Toroid Fusion

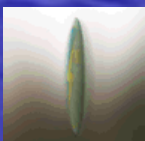
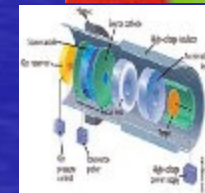
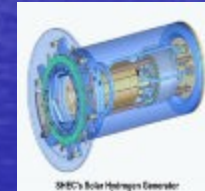
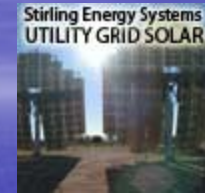

<http://Top100Energy.com>

- 6 Nanotube Super Capacitor Battery from MIT
- 7 Nanosolar roll-print thin-film solar cells
- 8 Focus Fusion - Plasma Focus Device for hydrogen-boron nuclear fusion
- 9 Enviromission Solar Tower
- 10 Quasiturbine Engine

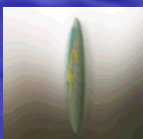
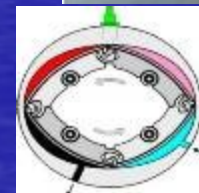

Top 10 Exotic Free Energy Technologies

Top 10 Exotic Free Energy Technologies

Sterling D. Allan, New Energy Congress (.org)

<http://FreeEnergyNews.com>

<http://PESWiki.com>

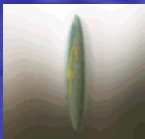

1

ERR Fluxgenerator by Noah's Ark Research Foundation

http://www.peswiki.com/index.php/Directory:ERR_Fluxgenerator_by_Noah's_Ark_Research_Foundation



Inventor, James B. Schwartz of the Philippines, has come up with a device that allegedly puts out as much as six kilowatts of electricity, tying into the Earth's frequencies, using a solid state arrangement in a panel made from "left-handed material" -- Aluminum and Bismuth interwoven with coils.

He's presently in process of testing and refining the design.



Top 10 Exotic Free Energy Technologies

Sterling D. Allan, New Energy Congress (.org)

<http://FreeEnergyNews.com>

<http://PESWiki.com>

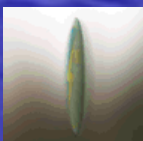

1

ERR Fluxgenerator

- **Affordable**
- **Renewable, Non-depleting**
- Environmentally Friendly
- **Continuous Output**
- **Load-following**
- **Robust, Low Maintenance**
- **Scalable**
- Portable
- Materials are Sustainable
- Practical
- Strong Team

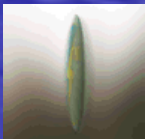



Steorn's Orbo – Electromagnetic OU

<http://www.peswiki.com/index.php/Directory:Steorn> Free Energy

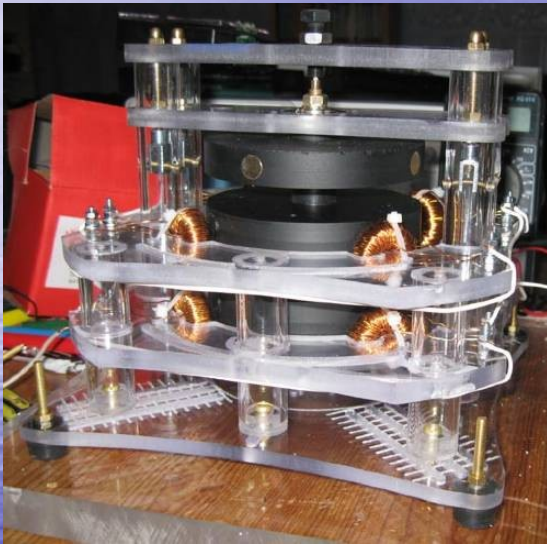

Steorn claims to have come up with a magnetic and electromagnetic system that puts out more energy than it consumes, drawing energy from the environment somehow.

Live, public demonstration presently underway from Jan. 8 through 31, 2010 in Dublin

<http://Steorn.com>



Top 10 Exotic Free Energy Technologies

Sterling D. Allan, New Energy Congress (.org)

<http://FreeEnergyNews.com>

<http://PESWiki.com>

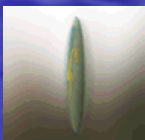

Steorn Milestones



- **2003** – Steorn undertook to develop more efficient micro generators
- **Aug. 18, 2006** – Announces free energy discovery in *Economist*
- **July 4, 2007** – Widely publicized demo of magnet motor prototype fails at the Kinetica Museum in London
- **Feb. 4, 2009** – Solicits teams of engineers and commercial interests to become part of a developer group
- **June 21, 2009** – Jury selected in 2006 issues verdict: “does not result in energy gain”
- **Dec. 15, 2009** – Public demonstration of e-Orbo, electromagnetic overunity, not very convincing
- **Jan. 8, 2010** – Next public demonstration launched



Steorn Orbo

- Affordable
- **Renewable, Non-depleting**
- Environmentally Friendly
- **Continuous Output**
- Load-following
- Robust, Low Maintenance
- **Scalable**
- Portable
- Materials are Sustainable
- Practical
- **Strong Team**

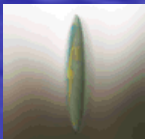

Boyce Hex Controller

http://www.peswiki.com/index.php/Directory:Bob_Boyce_Hex_Controller

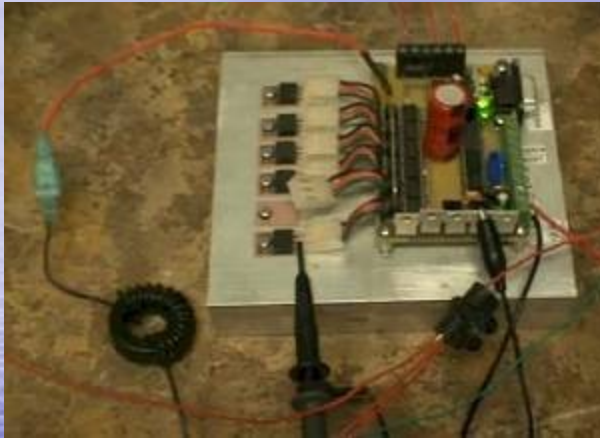

Bob Boyce's circuit runs from the same battery it is recharging, pulling energy from the environment somehow.



Child's toy recharged 35+ times

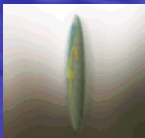

Boyce Hex Controller

- **Affordable**
- **Renewable, Non-depleting**
- **Environmentally Friendly**
- **Continuous Output**
- **Load-following**
- **Robust, Low Maintenance**
- **Scalable**
- **Portable**
- **Materials are Sustainable**
- Practical
- Strong Team

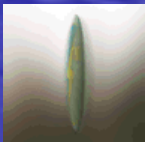

Boyce Electrolyzer Plans

[http://peswiki.com/index.php/OS:Bob Boyce Electrolyzer Plans](http://peswiki.com/index.php/OS:Bob_Boyce_Electrolyzer_Plans)



Open Source Project to clearly report, develop, advance the electrolyzer plans of Bob Boyce.

Yahoo!Groups forums

- WaterCar
- WorkingWaterCar
- Hydroxy

<http://www.bobbyoyce.org/>

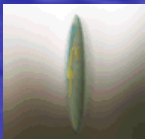

Boyce Electrolyzer

- **Affordable**
- **Renewable, Non-depleting**
- **Environmentally Friendly**
- Continuous Output
- **Load-following**
- Robust, Low Maintenance
- **Scalable**
- **Portable**
- **Materials are Sustainable**
- Practical
- Strong Team

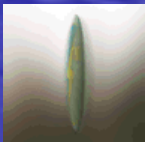

GEET Plasma Reactor

[http://peswiki.com/index.php/Directory:GEET Reactor by Paul Pantone](http://peswiki.com/index.php/Directory:GEET_Reactor_by_Paul_Pantone)

Paul Pantone of GEET released (interview) - After nearly 3.5 years of wrongful incarceration, primarily at Utah State Hospital, Mr. Pantone is now out and ready to move on, while also facilitating the international human rights organizations clean up a corrupt institution. A review of the GEET plasma reactor fuel efficiency technology. (*PESN*; June 1, 2009)

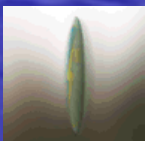
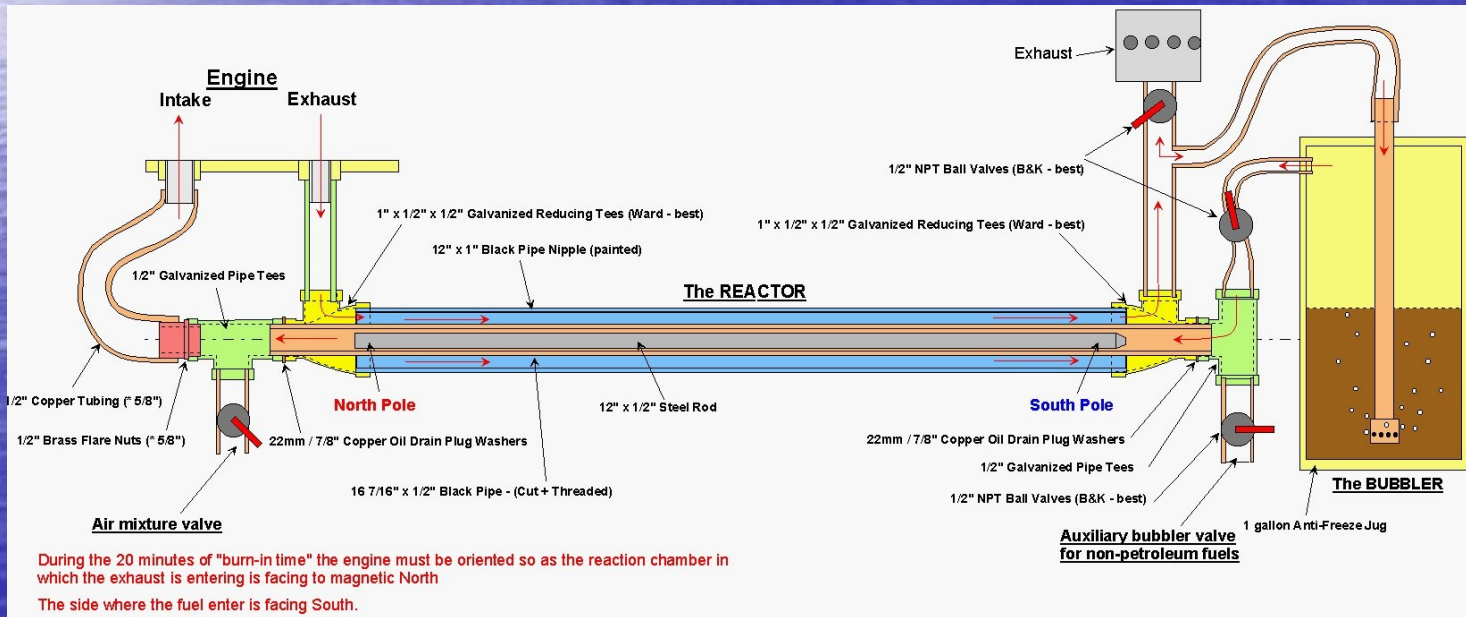

GEET Reactor

- **Affordable**
- Renewable, Non-depleting
- **Environmentally Friendly**
- *Continuous Output*
- **Load-following**
- Robust, Low Maintenance
- Scalable
- **Portable**
- Materials are Sustainable
- Practical
- *Strong Team*

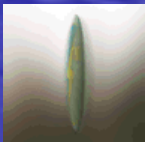

6

Top 100

Massive Yet Tiny Engine

[http://peswiki.com/index.php/Directory:Massive Yet Tiny \(MYT\) Engine](http://peswiki.com/index.php/Directory:Massive_Yet_Tiny_(MYT)_Engine)



Advantages:

- Low weight
- Can burn multiple fuels
- Can run on compressed air
- Fewer moving parts
- No reciprocating parts.
- High RPM potential
- No cylinder heads, no camshaft, no valves



<http://AngelLabsLLC.com>

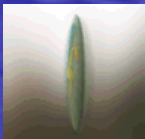

MYT Engine

- **Affordable**
- **Renewable, Non-depleting**
- **Environmentally Friendly**
- Continuous Output
- Load-following
- Robust, Low Maintenance
- Scalable
- **Portable**
- Materials are Sustainable
- Practical
- *Strong Team*

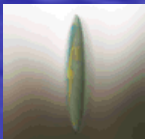

Magnacoaster Vorktex

[http://peswiki.com/index.php/Directory:Magna Coaster Motor Company](http://peswiki.com/index.php/Directory:Magna_Coaster_Motor_Company)



<http://Vorktex.ca>

Solid state system involves some very high-powered permanent magnets and some specially-wound coils, along with some proprietary circuitry.

The company's website lists a number of products of varying power outputs (including 4.8 kW; 9 kW; 12 kW) for sale. No units have yet been delivered to customers, but the company says that the final modifications are being made to ship the first batch of products.



Richard Willis

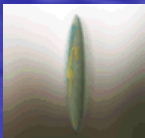

Magnacoaster Vorktex

- **Affordable**
- **Renewable, Non-depleting**
- **Environmentally Friendly**
- **Continuous Output**
- Load-following
- Robust, Low Maintenance
- Scalable
- **Portable**
- Materials are Sustainable
- Practical
- *Strong Team*

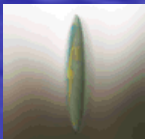

PlasmERG Noble Gas Engine

http://peswiki.com/index.php/Directory:Plasma_Energy_Controls'_Plasma_Expansion_Motor

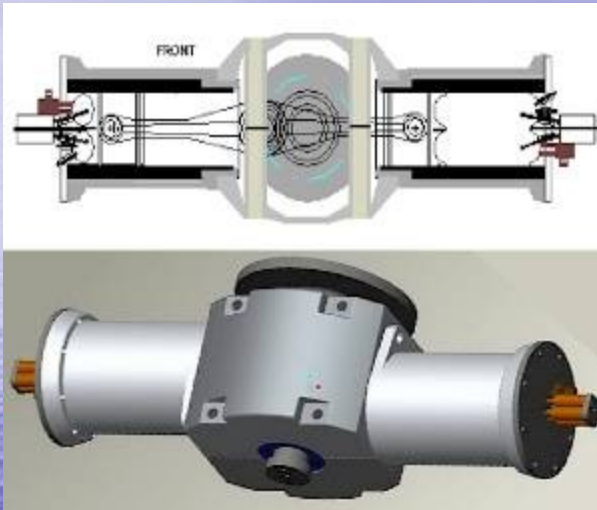

The noble (inert) gas engine by PlasmERG, Inc, with just five moving parts, would allegedly cost 1/3 what a regular engine of comparable output would cost. Meanwhile, its fuel cost would be negligible. It's kind of like a Stirling engine -- a sealed system -- except that the expanding component is internal, and comes by way of a plasma form of inert, noble gasses, which are not consumed in the process, and which are environmentally benign anyway.

<http://PlasmERG.com>

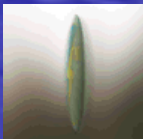

PlasmERG Engine

- **Affordable**
- **Renewable, Non-depleting**
- **Environmentally Friendly**
- **Continuous Output**
- Load-following
- Robust, Low Maintenance
- Scalable
- **Portable**
- Materials are Sustainable
- Practical
- Strong Team

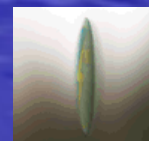

Searl Effect Generator (SEG)

[http://www.peswiki.com/index.php/Directory:Searl_Effect_Generator \(SEG\)](http://www.peswiki.com/index.php/Directory:Searl_Effect_Generator_(SEG))

Capable of cheaply and safely producing electricity without fuel, pollution, friction, or noise. Anti-gravity effects also involved.

<http://JohnSearlStory.com>

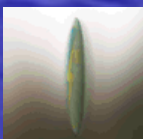
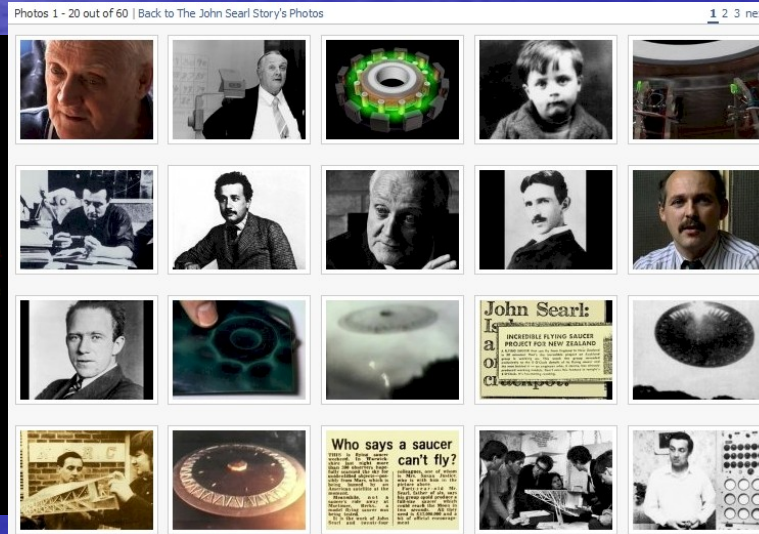

Searl Effect Generator

- **Affordable**
- **Renewable, Non-depleting**
- **Environmentally Friendly**
- **Continuous Output**
- **Load-following**
- Robust, Low Maintenance
- Scalable
- **Portable**
- Materials are Sustainable
- Practical
- Strong Team

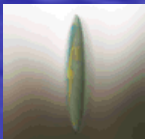

JET Thermal Products

http://peswiki.com/index.php/Directory:JET_Thermal_Products

JET Energy is Developing Cold Fusion Technology -

Having brought cold fusion through many generations of advancement, Mitchell Swartz' company is in process of developing the technology to the point that it could be commercialized. They made history in 2003 by running a large public demonstration for five consecutive days at MIT.

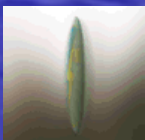

Cold Fusion

http://peswiki.com/energy/Directory:Cold_Fusion

20 Years to New Head Turn by Scientific Community

Scientists in possible cold fusion breakthrough

- Researchers at a US Navy laboratory have unveiled what they say is "significant" evidence of cold fusion, a potential energy source that ... (*AFP* - Mar 24, 2009)

Cold Fusion at 20: Hope Springs Eternal - For those of you with memories that go back to 1989, the news that cold fusion has not slinked off into the abyss might come as a bit of a surprise. ... (*Newsweek* - Mar 24, 2009)

After 20 years: New life for cold fusion? - By Katherine Harmon in 60-Second Science Blog Is the science community warming to cold fusion? It's been 20 years to the day since Martin Fleischmann and ... (*Scientific American* - Mar 23, 2009)

Cold fusion experimentally confirmed - US Navy researchers claimed to have experimentally confirmed cold fusion in a presentation at the American Chemical Society's annual ... (*EETimes.com* - Mar 23, 2009)

New Cold Fusion Evidence Reignites Hot Debate

- On Monday, scientists at the American Chemical Society (ACS) meeting in Salt Lake City announced a series of experimental results that they ... (*IEEE Spectrum* - Mar 25, 2009)

Cold fusion a possible source of power? - There is compelling new scientific evidence for the existence of low-energy nuclear reactions (LENR) according to one group of scientists. ... (*Nuclear Engineering* - Mar 25, 2009)

New evidence of cold fusion - Researchers from the US Navy's Space and Naval Warfare Systems Center (SPAWAR) have reportedly observed lab-controlled cold fusion. ... (*Examiner.com* - Mar 24, 2009)

Cold fusion makes a comeback - That controversial table-top experiment dubbed cold fusion simply won't die. In fact, it isn't even fading away. ... (*KSL-TV* - Mar 23, 2009)

Etc.

Top 10 Exotic Free Energy Technologies

Sterling D. Allan, New Energy Congress (.org)

<http://FreeEnergyNews.com>

<http://PESWiki.com>

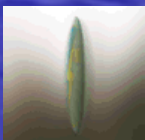

Jet Thermal Products

- Affordable
- **Renewable, Non-depleting**
- **Environmentally Friendly**
- **Continuous Output**
- Load-following
- **Robust, Low Maintenance**
- Scalable
- Portable
- Materials are Sustainable
- Practical
- Strong Team

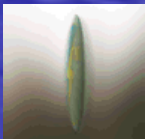

Green Power, Inc. – Trash to Diesel

[http://www.peswiki.com/index.php/Directory:Green_Power_Inc's_NanoDiesel:Catalytic_Pressureless_Depolymerization_\(Oiling\)](http://www.peswiki.com/index.php/Directory:Green_Power_Inc's_NanoDiesel:Catalytic_Pressureless_Depolymerization_(Oiling))



100 ton/day production prototype plant
completed March 2008

<http://CleanEnergyProjects.com>

GPI's process inexpensively converts biomass and household waste into high grade diesel fuel.

GPI's plant processes municipal and other waste in a low heat and low pressure, proprietary catalytic system, converting the feedstock into high grade fuel, including diesel, kerosene, and fuel oil; as well as electricity and an asphalt component.

The preparation of incoming waste stream includes chopping, extraction of metals, glass, and sand, so that approximately 2/3 of the feedstock is able to be run through the unit to produce fuel and electricity.

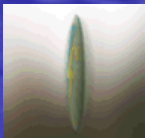

Green Power Inc.

- Affordable
- **Renewable, Non-depleting**
- Environmentally Friendly
- **Continuous Output**
- *Load-following*
- *Robust, Low Maintenance*
- *Scalable*
- *Portable*
- Materials are Sustainable
- Practical
- *Strong Team*

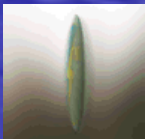

Runners Up

Many other Technologies Could Have Been Featured

- Blacklight Power
- Roger Stringham's Sonofusion
- Tesla-based and pyramidal power converters
- Thorium-based Electrical Power Generation
- Betavoltaics
- Hydrokinetic systems
- Rauen Environmental Heat Engine
- Nelson Scientific's Electron Capture
- Focus Fusion
- Timothy Thrapp
- Magnetic Power Inc
- Orion Projects
- Keppean Scalar Motor
- Perendev



Waste-to-Building Materials

Announcement expected Feb. 2010

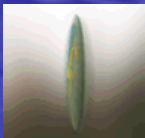

Kapanadze Free Energy Generator

http://peswiki.com/index.php/Directory:Kapanadze_Free_Energy_Generator

Kapanadze's 100 kW free energy device third-party tested - A video has been posted showing the setup of the one hundred kilowatt free energy generator by Tariel Kapanadze's group in the Republic of Georgia as it is being third-party tested, complete with large coils, arcing spark gaps, huge capacitors and mesh screens, set atop a ~one-inch-thick glass. (*PESN*; July 24, 2009)

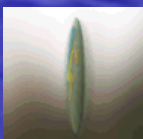

Kapandze

- Affordable
- **Renewable, Non-depleting**
- **Environmentally Friendly**
- **Continuous Output**
- Load-following
- **Robust, Low Maintenance**
- Scalable
- Portable
- Materials are Sustainable
- Practical
- *Strong Team*

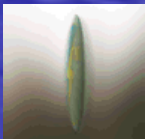

14

World Improvement through the Spirit (WITTS) Ministry

http://peswiki.com/index.php/Directory:World_Improvement_Through_The_Spirit_Ministries

Claims to have around 100 sundry exotic energy technologies for sale/license, including versions of gravity motors, engines that run on water, radiant energy devices (solid state or mechanical), inertial propulsion devices, and pollution remediation.

<http://www.witts.ws/>

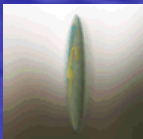

Magnetic Power Inc.

http://peswiki.com/index.php/Directory:Magnetic_Power_Inc

“Our work has the potential to dramatically assist the utility and automotive industries.”

Two large utilities are among major domestic companies that have signed NonDisclosure Agreements.

Company assets are being acquired by Chava Energy

<http://www.chavaenergy.com>

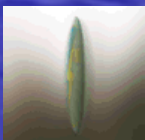
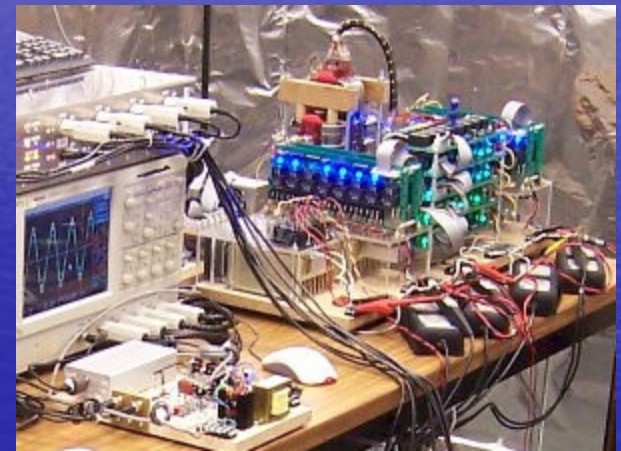

BlackLight Power

http://peswiki.com/index.php/Directory:Blacklight_Power

BlackLight Power signs sixth utility deal to produce power from water - One of the more controversial and mysterious cleantech solutions on the market, announced today that it has landed a commercial licensing deal with Maryland-based utility **Akridge Energy**. This is the sixth such contract for the company, which claims to have technology capable of generating energy using only water. (*Venture Beat*, July 30, 2009)

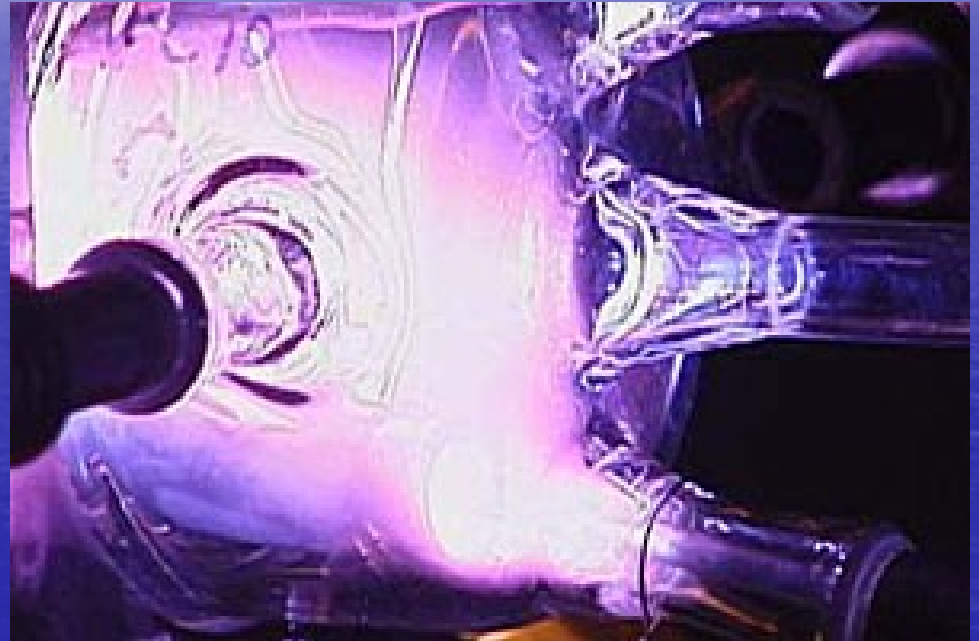

**hydrogen + catalyst + heat →
"hydrino" + excess heat**



REMGen

http://peswiki.com/index.php/Directory:REMGen_by_REM_Source%2C_LLC

REM Source, LLC of Oklahoma claims to have a production prototype home power free energy generator in the range of 5 – 12 kilowatts.

ROI estimate: 3-4 years.

Was going to give a semi-public demo on Aug. 7, 2009, but is going to keep it private for politics of science reasons.

<http://REMGen.com>

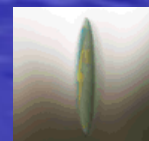

Perendev Magnet Motor

[http://peswiki.com/index.php/Directory:Perendev_Power_Developments_Pty_\(Ltd\)](http://peswiki.com/index.php/Directory:Perendev_Power_Developments_Pty_(Ltd))

PERENDEV POWER DEVELOPMENTS



See <http://Perendev.com>

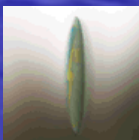

Q. Do you think an all-magnet motor (no electrical input) is possible?

12 Votes	1 Vote	3 Votes	39 Votes	38 Votes	1 Vote	23 Votes	8 Votes	838 Votes	23 Votes
3 Votes	32 Votes	2 Votes	5 Votes	57 Votes	2 Votes	15 Votes	10 Votes	125 Votes	7 Votes
3 Votes	2 Votes	13 Votes	1 Vote	14 Votes	3 Votes	1 Vote	2 Votes	1 Vote	13 Votes
90 Votes	84 Votes	11 Votes	2 Votes	2 Votes	17 Votes	14 Votes	16 Votes	2 Votes	1 Vote
11 Votes	5 Votes	8 Votes	11 Votes	4 Votes	2 Votes	5 Votes	1 Vote	11 Votes	10 Votes
3 Votes	1 Vote	8 Votes	1 Vote	3 Votes	3 Votes	1 Vote	7 Votes	10 Votes	3 Votes
12 Votes	1 Vote	1 Vote	1 Vote	5 Votes	1 Vote	7 Votes	1 Vote	8 Votes	2 Votes
5 Votes	12 Votes	1 Vote	2 Votes	1 Vote	3 Votes	1 Vote	15 Votes	2 Votes	1 Vote
1 Vote	3 Votes	1 Vote	1 Vote	1 Vote	1 Vote	1 Vote	1 Vote	9 Votes	

1770 votes . . . as of July 17, 2009
Since May 30, 2009

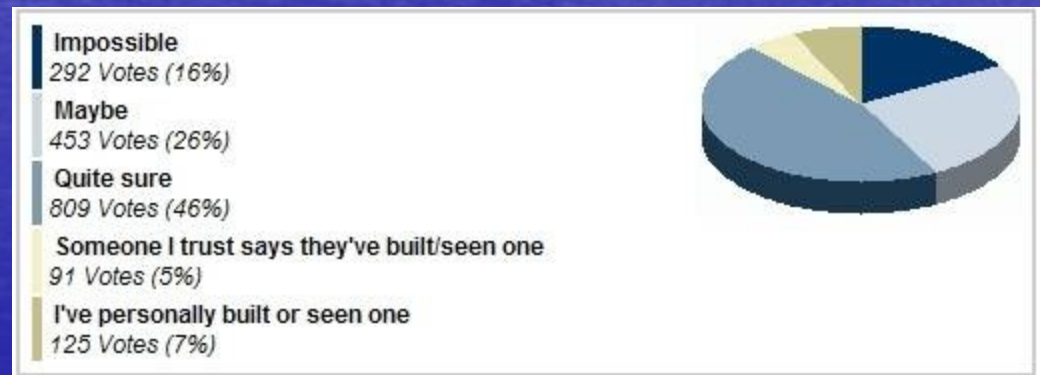

See: http://www.99polls.com/poll_67598

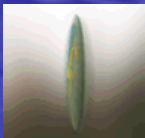

A serene background image featuring a clear blue sky with wispy white clouds at the top. Below the sky is a vast, calm blue ocean. A bright sun is positioned on the left side of the horizon, creating a shimmering reflection on the water's surface that extends towards the center. The overall color palette is dominated by various shades of blue, from deep cerulean to light sky blue.

Yours?

Open Source Energy

The Ideal Project

- Works / Validated
- Easy to Replicate
- Inexpensive
- Unencumbered IP
- Sexy

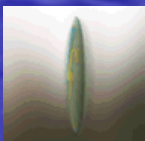



Jeane Manning

Sociologist,
investigative journalist

Author of *The Coming
Energy Revolution*

Advisor, *New Energy
Congress*

Joel Garbon

Industrial science consultant,
businessman, new energy
inventor advocate

Author of *Energy Innovation Act*
draft legislation

President, *The New Energy
Movement*

Founding Member, *New Energy
Congress*



JEANE MANNING & JOEL GARBON

BREAK THROUGH POWER

How quantum-leap
new energy inventions
can **transform our world**

Top 10 Exotic Free Energy Technologies

Sterling D. Allan, New Energy Congress (.org)

<http://FreeEnergyNews.com>

<http://PESWiki.com>



Law of Attraction

- Build it, they will come
- Magnet for great technologies
- Watering hole for networking
- Bring attention to the most deserving
- Facilitate emergence of best technologies



Subscribe to FreeEnergyNews.com

<http://www.freeenergynews.com/newsletters/>

Renewable energy technology break-through developments from around the world. News bullets are archived by topic in our extensive energy [directory](#). Advisory input provided by the [New Energy Congress](#), who reviews the best technologies for feature in the [Top 100 Energy Technologies](#) listing.



Top 10 Exotic Free Energy Technologies

Sterling D. Allan, New Energy Congress (.org)

<http://FreeEnergyNews.com>

<http://PESWiki.com>

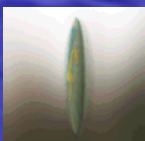

Thank You

Q&A

Websites

<http://PESWiki.com> – energy wiki

<http://FreeEnergyNews.com> – daily news

<http://PESN.com> – our news stories

<http://NewEnergyCongress.org>

Contact

Email: sterlingda@pureenergysystems.com

Cell/home office: +1-801-407-1292

Mount Pleasant, Utah



Available Online

This PowerPoint presentation
can be downloaded for free
from PESWiki.com
keyword: "Earth Transformation"

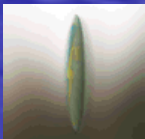



Top 10 Exotic Free Energy Technologies

Sterling D. Allan, New Energy Congress (.org)

<http://FreeEnergyNews.com>

<http://PESWiki.com>

